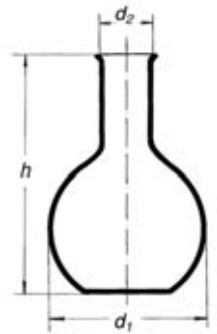

632 * *** *** Banka s plochým dnom** **Kat.č. 10**

úzkohrdlá, vyhnutý okraj

***	***	***	Objem (ml)	d ₁ (mm)	d ₂ (mm)	h (mm)	Balenie (ks)
411	117	050	50	51	22	100	10
417	117	100	100	64	22	110	10
417	117	250	250	85	34	140	10
417	117	500	500	105	34	170	10
411	117	940	1000	131	42	200	10
411	117	950	2000	166	50	250	6
411	117	954	4000	207	50	300	2
411	117	958	6000	236	65	340	2
411	117	966	10000	279	65	400	1

632 411 117 ***
632 417 117 *****632 411 205 *** Banka s guľatým dnom** **Kat.č. 15**

úzkohrdlá, vyhnutý okraj

***	Objem (ml)	d ₁ (mm)	d ₂ (mm)	h (mm)	Balenie (ks)
050	50	51	22	105	10
100	100	64	22	115	10
250	250	85	34	145	10
500	500	105	34	175	10
940	1000	131	42	210	10
950	2000	166	50	260	6
954	4000	207	50	315	2
958	6000	236	65	355	2
966	10000	279	65	420	1

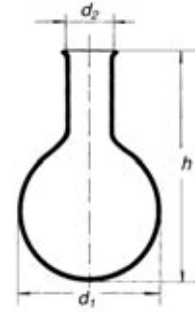

632 411 205 ***

632 411 103 * Banka titračná** **Kat.č. 18**

s plochým dnom, širokohrdlá, vyhnutý okraj

***	Objem (ml)	d ₁ (mm)	d ₂ (mm)	h (mm)	Balenie (ks)
050	50	51	34	100	10
100	100	64	34	110	10
250	250	85	50	140	10
500	500	105	50	170	10
940	1000	131	50	200	10
950	2000	166	76	250	6

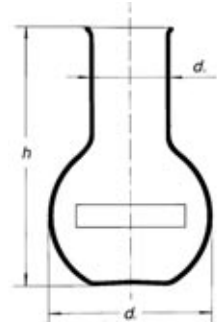

632 411 103 ***

632 * *** *** Banka kužeľová** **Kat.č. 24**

podľa Erlenmeyera, úzkohrdlá

***	***	***	Objem (ml)	d ₁ (mm)	d ₂ (mm)	h (mm)	Balenie (ks)
411	119	025	25	42	22	70	10
411	119	050	50	51	22	85	10
417	119	100	100	64	22	105	10
411	119	200	200	79	34	131	10
417	119	250	250	85	34	140	10
411	119	300	300	87	34	156	10
417	119	500	500	105	34	175	10
417	119	940	1000	131	42	220	10
411	119	950	2000	166	50	280	6
411	119	952	3000	187	50	310	6
411	119	956	5000	220	50	365	2

632 411 119 ***
632 417 119 *****632 *** *** *** Banka kužeľová** **Kat.č. 25**

podľa Erlenmeyera, širokohrdlá

***	***	***	Objem (ml)	d ₁ (mm)	d ₂ (mm)	h (mm)	Balenie (ks)
411	106	025	25	42	32	70	10
411	106	050	50	51	34	85	10
417	106	100	100	64	34	105	10
411	106	200	200	79	50	131	10
417	106	250	250	85	50	135	10
411	106	300	300	87	50	156	10
417	106	500	500	105	50	170	10
411	106	940	1000	131	50	215	10
411	106	950	2000	153	72	280	6

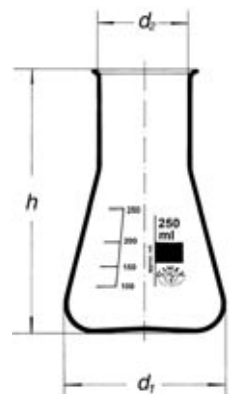
632 411 106 ***
632 417 106 *****632 411 210 *** Banka mineralizačná** **Kat.č. 51**

podľa Kjeldahla

***	Objem (ml)	d ₁ (mm)	d ₂ (mm)	h (mm)	Balenie (ks)
050	50	49	22	200	10
100	100	60	34	200	10
250	250	81	34	270	10
500	500	101	34	300	10
940	1000	126	34	350	7

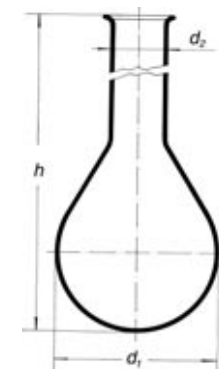

632 411 210 ***

1.1. Laboratórne sklo

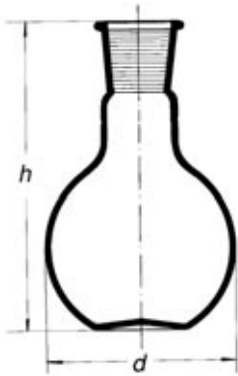

632 426 217 ***

632 426 217 *** Banka s plochým dnom a NZ Kat.č. 8003

***	Objem (ml)	NZ (mm)	d (mm)	h (mm)	Balenie (ks)
050	50	14/23	51	100	10
051	50	19/26	51	100	10
052	50	29/32	51	100	10
100	100	14/23	64	110	10
101	100	19/26	64	110	10
102	100	29/32	64	110	10
250	250	29/32	85	140	10
251	250	45/40	85	140	10
500	500	29/32	105	170	10
501	500	45/40	105	170	10
940	1000	29/32	131	200	10
941	1000	45/40	131	200	10
950	2000	29/32	166	250	6
951	2000	45/40	166	250	6
954	4000	45/40	207	300	2
958	6000	60/46	236	340	2
966	10000	60/46	279	400	1

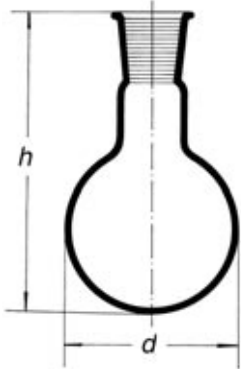

632 426 219 ***

632 426 219 *** Banka s guľatým dnom a NZ Kat.č. 8004

***	Objem (ml)	NZ (mm)	d (mm)	h (mm)	Balenie (ks)
050	50	14/23	51	105	10
051	50	19/26	51	105	10
052	50	29/32	51	105	10
100	100	14/23	64	115	10
101	100	19/26	64	115	10
102	100	29/32	64	115	10
250	250	29/32	85	145	10
251	250	45/40	85	145	10
500	500	29/32	105	175	10
501	500	45/40	105	175	10
940	1000	29/32	131	210	10
941	1000	45/40	131	210	10
950	2000	29/32	166	260	6
951	2000	45/40	166	260	6
954	4000	45/40	207	315	2
958	6000	60/46	236	355	2
966	10000	60/46	279	420	1

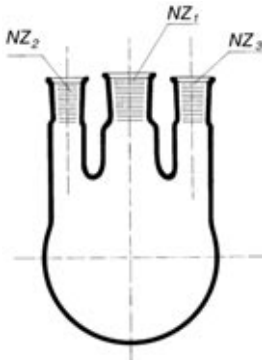

632 426 222 ***

632 426 222 *** Banka destilačná guľaté dno, dva postranné tubusy s NZ Kat.č. 8016

***	Objem (ml)	NZ ₁ (mm)	NZ ₂ (mm)	NZ ₃ (mm)	Balenie (ks)
250	250	29/32	14/23	14/23	10
500	500	29/32	14/23	14/23	10
940	1000	29/32	14/23	29/32	10
950	2000	29/32	14/23	29/32	8
954	4000	45/40	14/23	29/32	6
958	6000	60/46	14/23	29/32	3

Dodávame viac variant destilačných baniek.

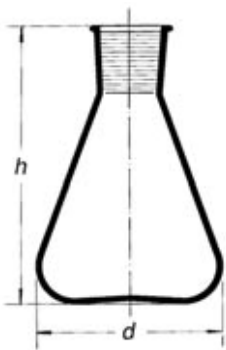

632 426 207 ***

632 426 207 *** Banka kužeľová podľa Erlenmeyera s NZ Kat.č. 8024

***	Objem (ml)	d (mm)	h (mm)	NZ (mm)	Balenie (ks)
025	25	42	70	14/23	10
026	25	42	70	19/26	10
050	50	51	85	14/23	10
051	50	51	85	19/26	10
052	50	51	85	29/32	10
100	100	64	105	14/23	10
101	100	64	105	19/26	10
102	100	64	105	29/32	10
200	200	79	130	29/32	10
252	250	85	135	14/23	10
250	250	85	135	29/32	10
251	250	85	135	45/40	10
300	300	87	155	29/32	10
500	500	105	170	29/32	10
501	500	105	170	45/40	10
940	1000	131	215	29/32	10
941	1000	131	215	45/40	10
950	2000	166	275	29/32	6
951	2000	166	275	45/40	6

632 426 731 * Banka podľa Erlenmeyera so šrobovacím uzáverom Kat.č. 8023**

S modrým uzáverom z PP (odolnosť do 240 °C),
môžeme dodať s červeným uzáverom z PBT (odolnosť do 180 °C).

***	Objem (ml)	d (mm)	h (mm)	GL (mm)	Balenie (ks)
100	100	64	100	25	10
250	250	85	140	32	10
500	500	105	175	32	10
940	1000	131	215	32	10

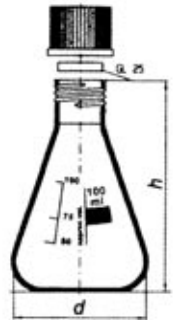

632 426 731 ***

634 302 177 * Banka podľa Erlenmeyera kultivačná**

***	Objem (ml)	Priemer banky (mm)	Výška (mm)	Balenie (ks)
124	100	64	112	10
132	200	79	136	10
136	250	85	145	10
139	300	87	161	10
144	500	105	183	10
154	1000	131	232	1
163	2000	166	305	1

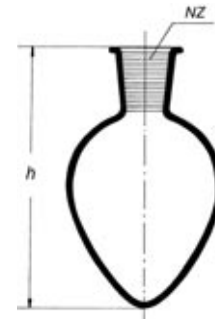

632 426 372 ***

632 426 371 * Banka so zaobleným dnom a NZ Kat.č. 8026**

***	Objem (ml)	NZ (mm)	d (mm)	h (mm)	Balenie (ks)
010	10	14/23	32	50	100
025	25	14/23	42	60	100
050	50	14/23	54	74	100
100	100	14/23	65	88	90
250	250	14/23	90	116	32

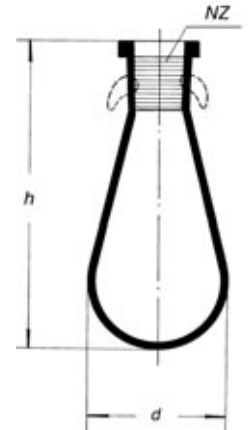

632 426 374 ***

632 426 372 * Banka srdcovitá a NZ Kat.č. 8027**

***	Objem (ml)	NZ (mm)	h (mm)	Balenie (ks)
010	10	14/23	62	100
025	25	14/23	75	100
050	50	14/23	88	100
100	100	14/23	103	60
250	250	14/23	130	32

632 426 374 * Banka kvapkovitá a NZ Kat.č. 8029**

***	Objem (ml)	NZ (mm)	d (mm)	h (mm)	Balenie (ks)
010	10	14/23	26	60	100
025	25	14/23	34	80	100
050	50	14/23	42	100	100
100	100	14/23	52	123	60
250	250	14/23	72	170	32

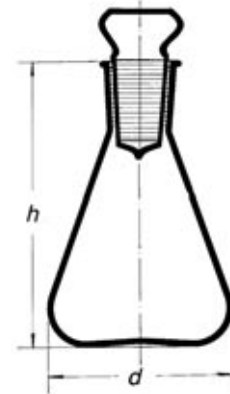

632 426 210 ***

632 426 210 * Banka na stanovenie jódového čísla so sklenenou zátkou Kat.č. 8481**

***	Objem (ml)	NZ (mm)	h (mm)	d (mm)	Balenie (ks)
050	50	19/26	85	51	10
100	100	19/26	105	64	10
250	250	29/32	135	85	10
500	500	29/32	170	105	10
940	1000	29/32	215	131	10

632 425 220 * Banka frakčná s natavenou trubicou dole Kat.č. 41/A**

***	Objem (ml)	d ₁ (mm)	d ₂ (mm)	h (mm)	h ₁ (mm)	Balenie (ks)
025	25	41	22	110	46	10
050	50	51	22	120	46	10
100	100	64	22	150	58	10
250	250	85	34	200	76	10
500	500	105	34	250	96	10
940	1000	131	34	300	112	8

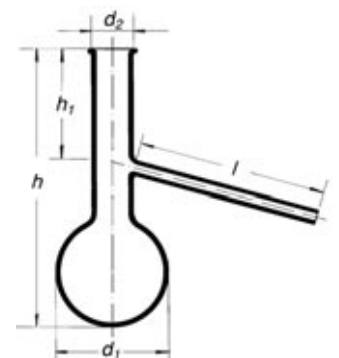

632 425 220 ***

Banku frakčnú je možné dodať v prevedení s natavenou trubicou v strede kat. č. 41/B, s trubicou v hornej tretine kat. č. 41/C, či v prevedení podľa Englera kat. č. 42.

1.1. Laboratórne sklo

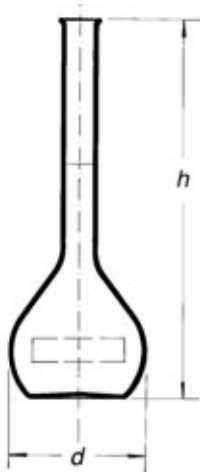

632 431 011 ***

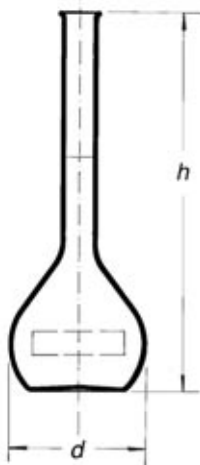

632 431 022 ***

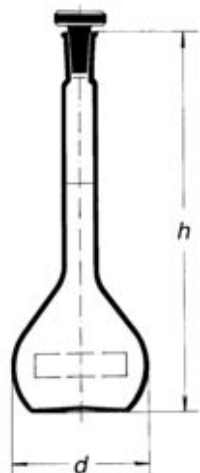

632 431 071 ***

632 431 011 *** Banka odmerná s vyhnutým okrajom, bez zátky, trieda A					Kat.č. 1502/A
***	Objem (ml)	Presnosť (±ml)	d (mm)	h (mm)	Balenie (ks)
018	5	0,025	22	70	10
019	10	0,025	27	90	10
023	25	0,04	40	110	10
025	50	0,06	50	140	10
030	100	0,10	60	170	10
037	200	0,15	75	210	10
038	250	0,15	80	220	10
043	500	0,25	100	260	10
044	1000	0,40	125	300	10
046	2000	0,60	160	370	6
047	5000	1,20	215	475	1

632 431 021 *** Banka odmerná, ciachovaná s vyhnutým okrajom, bez zátky, trieda A					Kat.č. 1502/AK
***	Objem (ml)	Presnosť (±ml)	d (mm)	h (mm)	Balenie (ks)
018	5	0,025	22	70	1
019	10	0,025	27	90	1
023	25	0,04	40	110	1
025	50	0,06	50	140	1
030	100	0,10	60	170	1
037	200	0,15	75	210	1
038	250	0,15	80	220	1
043	500	0,25	100	260	1
044	1000	0,40	125	300	1
046	2000	0,60	160	370	1

632 431 022 *** Banka odmerná, ciachovaná s over. listom s vyhnutým okrajom, bez zátky, trieda A					Kat.č. 1502/AK+OL
***	Objem (ml)	Presnosť (±ml)	d (mm)	h (mm)	Balenie (ks)
018	5	0,025	22	70	1
019	10	0,025	27	90	1
023	25	0,04	40	110	1
025	50	0,06	50	140	1
030	100	0,10	60	170	1
037	200	0,15	75	210	1
038	250	0,15	80	220	1
043	500	0,25	100	260	1
044	1000	0,40	125	300	1
046	2000	0,60	160	370	1

632 431 071 *** Banka odmerná s NZ a sklenenou zátkou, trieda A						Kat.č. 1503/AS
***	Objem (ml)	Presnosť (±ml)	d (mm)	h (mm)	NZ	Balenie (ks)
018	5	0,025	22	70	7 / 16	10
019	10	0,025	27	90	7 / 16	10
023	25	0,04	40	110	10 / 19	10
025	50	0,06	50	140	12 / 21	10
030	100	0,10	60	170	12 / 21	10
037	200	0,15	75	210	14 / 23	10
038	250	0,15	80	220	14 / 23	10
043	500	0,25	100	260	19 / 26	10
044	1000	0,40	125	300	24 / 29	10
046	2000	0,60	160	370	29 / 32	6
047	5000	1,20	215	475	34 / 35	1

632 431 081 *** Banka odmerná, ciachovaná s NZ a sklenenou zátkou, trieda A						Kat.č. 1503/ASK
***	Objem (ml)	Presnosť (±ml)	d (mm)	h (mm)	NZ	Balenie (ks)
018	5	0,025	22	70	7 / 16	1
019	10	0,025	27	90	7 / 16	1
023	25	0,04	40	110	10 / 19	1
025	50	0,06	50	140	12 / 21	1
030	100	0,10	60	170	12 / 21	1
037	200	0,15	75	210	14 / 23	1
038	250	0,15	80	220	14 / 23	1
043	500	0,25	100	260	19 / 26	1
044	1000	0,40	125	300	24 / 29	1
046	2000	0,60	160	370	29 / 32	1

632 431 082 * Banka odmerná, ciachovaná s ověř. listovm Kat.č. 1503/ASK+OL**
s NZ a sklenenou zátkou, trieda A

***	Objem (ml)	Presnosť (±ml)	d (mm)	h (mm)	NZ	Balenie (ks)
018	5	0,025	22	70	7 / 16	1
019	10	0,025	27	90	7 / 16	1
023	25	0,04	40	110	10 / 19	1
025	50	0,06	50	140	12 / 21	1
030	100	0,10	60	170	12 / 21	1
037	200	0,15	75	210	14 / 23	1
038	250	0,15	80	220	14 / 23	1
043	500	0,25	100	260	19 / 26	1
044	1000	0,40	125	300	24 / 29	1
046	2000	0,60	160	370	29 / 32	1

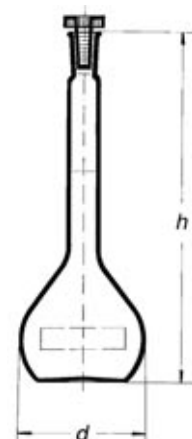

632 431 082 ***

632 431 622 * Banka odmerná Kat.č. 1503/APN**
s NZ a plastovou zátkou, trieda A

***	Objem (ml)	Presnosť (±ml)	d (mm)	h (mm)	NZ	Balenie (ks)
018	5	0,025	22	70	7 / 16	10
019	10	0,025	27	90	7 / 16	10
023	25	0,04	40	110	10 / 19	10
025	50	0,06	50	140	12 / 21	10
030	100	0,10	60	170	12 / 21	10
037	200	0,15	75	210	14 / 23	10
038	250	0,15	80	220	14 / 23	10
043	500	0,25	100	260	19 / 26	10
044	1000	0,40	125	300	24 / 29	10
046	2000	0,60	160	370	29 / 32	6
047	5000	1,2	215	475	34 / 35	1

632 431 632 * Banka odmerná, ciachovaná Kat.č. 1503/APNK**
s NZ a plastovou zátkou, trieda A

***	Objem (ml)	Presnosť (±ml)	d (mm)	h (mm)	NZ	Balenie (ks)
018	5	0,025	22	70	7 / 16	1
019	10	0,025	27	90	7 / 16	1
023	25	0,04	40	110	10 / 19	1
025	50	0,06	50	140	12 / 21	1
030	100	0,10	60	170	12 / 21	1
037	200	0,15	75	210	14 / 23	1
038	250	0,15	80	220	14 / 23	1
043	500	0,25	100	260	19 / 26	1
044	1000	0,40	125	300	24 / 29	1
046	2000	0,60	160	370	29 / 32	1

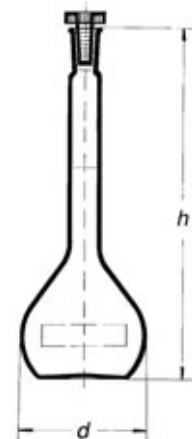

632 431 622 ***

632 431 633 * Banka odmerná, ciachovaná s over. lisom Kat.č. 1503/APNK+OL**
s NZ a plastovou zátkou, trieda A

***	Objem (ml)	Presnosť (±ml)	d (mm)	h (mm)	NZ	Balenie (ks)
018	5	0,025	22	70	7 / 16	10
019	10	0,025	27	90	7 / 16	10
023	25	0,04	40	110	10 / 19	10
025	50	0,06	50	140	12 / 21	10
030	100	0,10	60	170	12 / 21	10
037	200	0,15	75	210	14 / 23	10
038	250	0,15	80	220	14 / 23	10
043	500	0,25	100	260	19 / 26	10
044	1000	0,40	125	300	24 / 29	10
046	2000	0,60	160	370	29 / 32	6

634 990 011 * Banka odmerná, hnedá Kat.č. 1503/AH**
s NZ, trieda A, bez zátky (zátko PE vid. oddiel Plasty)

***	Objem (ml)	Presnosť (±ml)	d (mm)	h (mm)	NZ	Balenie (ks)
018	5	0,025	22	70	7 / 16	10
019	10	0,025	27	90	7 / 16	10
023	25	0,04	40	110	10 / 19	10
025	50	0,06	50	140	12 / 21	10
030	100	0,1	60	170	12 / 21	10
038	250	0,15	80	220	14 / 23	10
043	500	0,25	100	260	19 / 26	10
044	1000	0,40	125	300	24 / 29	10
046	2000	0,60	160	370	29 / 32	4
047	5000	1,20	215	475	29 / 32	4

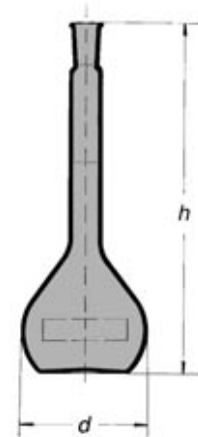

634 990 011 ***

1.1. Laboratórne sklo

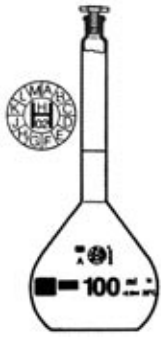

634 702 822 ***

634 702 822 *** Banka odmerná, HIRSCHMANN Kat.č.1503/APH

s NZ, trieda A, plastovou zátkou, hnedá graduácia, overené konformity

***	Objem (ml)	Presnosť (mm)	h (mm)	NZ (mm)	Balenie (ks)
153	5	0,025	70	10 / 19	2
161	10	0,025	90	10 / 19	2
170	25	0,04	110	10 / 19	2
175	50	0,06	140	12 / 21	2
180	100	0,10	170	12 / 21	2
185	200	0,15	210	14 / 23	2
186	250	0,15	220	14 / 23	2
190	500	0,25	260	19 / 26	2
193	1000	0,40	300	24 / 29	2
194	2000	0,60	370	29 / 32	2

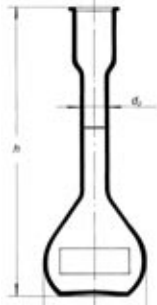

632 431 478 ***

632 431 478 *** Banka podľa Kohlrauscha trieda A Kat.č. 1507/A

***	Objem (ml)	Presnosť	d1 (mm)	d2 (mm)	h (mm)	Balenie (ks)
030	100	0,10	60	16	170	1
037	200	0,15	75	19	210	1

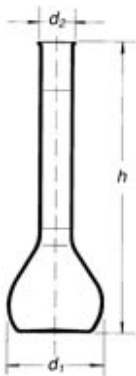

632 431 510 ***

632 431 480 *** Banka podľa Stifta trieda A Kat.č. 1508

***	Objem (ml)	Balenie (ks)
037	200	1

632 431 510 *** Banka cukrovnícka s dvomi značkami Kat.č. 1509

***	Objem (ml)	d1 (mm)	d2 (mm)	h (mm)	Balenie (ks)
025	50 / 55	47	18	155	10
030	100 / 110	58	21	180	10
037	200 / 220	73	24	200	10



632 431 560 ***

632 431 *** Banka s deleným hrdlom Kat.č. 1520

***	Objem (ml)	Tolerancia (ml)	h (mm)	Balenie (ks)
560 725	50	+5	105	1
560 830	100	+10	205	1
560 837	200	+20	245	1
560 938	250	+25	280	1
561 143	500	+50	320	1
561 144	1000	+100	400	1



632 521 002 000

632 521 001 *** Banka na biele krvinky Kat.č. 3015

***	d (mm)	h (mm)	Balenie (ks)
000	18	32	1

632 521 002 *** Banka na červené krvinky Kat.č. 3016

***	d (mm)	h (mm)	Balenie (ks)
000	29	51	1

632 425 900 *** Banka na akupunktúru Kat.č. SV877

***	Typ	d (mm)	h (mm)	Balenie (ks)
035	malá	35	50	-
050	veľká	50	60	-

632 438 010 *** Butyrometer Gerber, na mlieko Kat.č. 7330

***	Obsah tuku (%)	Balenie (ks)
500	0-5	1
600	0-6	1
700	0-7	1
800	0-8	1

632 438 010 *** Butyrometer Gerber, na mlieko, over. listom Kat.č. 7330+OL

***	Obsah tuku (%)	Balenie (ks)
520	0-5	1
620	0-6	1
720	0-7	1
820	0-8	1

632 438 *** Butyrometer Roeder, na smotanu 5 g

***	Obsah tuku (%)	Delen.stupnice	Kat.č.	Balenie (ks)
102 000	0-20	0,5	7333	1
104 000	0-40	0,5	7334	1
105 500	0-55	0,5	7335	1

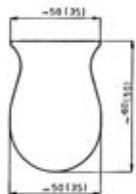

632 425 900 ***



632 438 010 ***



632 438 105 500

632 438 *** *** Butyrometer Roeder, na smotanu 5 g, s over. listom				
*** ***	Obsah tuku (%)	Delen.stupnice	Kat.č.	Balenie (ks)
102 020	0-20	0,5	7333+OL	1
104 020	0-40	0,5	7334+OL	1
105 520	0-55	0,5	7335+OL	1

632 438 *** *** Butyrometer Kohler-Funke, na smotanu 5 ml				
*** ***	Obsah tuku (%)	Delen.stupnice	Kat.č.	Balenie (ks)
112 000	0-20	0,5	7337	1
114 000	0-40	0,5	7339	1
115 500	0-55	0,5	7341	1

632 438 *** *** Butyrometer Kohler-Funke, na smotanu 5 ml, s over.listom				
*** ***	Obsah tuku (%)	Delen.stupnice	Kat.č.	Balenie (ks)
112 020	0-20	0,5	7337+OL	1
114 020	0-40	0,5	7339+OL	1
115 520	0-55	0,5	7341+OL	1

632 438 *** *** Butyrometer Van Gulik, na syr 3 g				
*** ***	Obsah tuku (%)	Delen.stupnice	Kat.č.	Bal. (ks)
202 000	0-20	0,5	7342	1
204 000	0-40	0,5	7343	1

632 438 *** *** Butyrometer Van Gulik, na syr 3 g, s over. listom				
*** ***	Obsah tuku (%)	Delen.stupnice	Kat.č.	Balenie (ks)
202 020	0-20	0,5	7342/OL	1
204 020	0-40	0,5	7343/OL	1

632 438 810 000 Pohárik k butyrometrom Kat.č. 8100

632 438 820 000 Lodička k butyrometrom Kat.č.8200

632 435 006 *** Byreta Kat.č. 1565/B			
***	Objem (ml)	Delenie (ml)	Balenie (ks)
619	10	0,05	5
723	25	0,1	5
725	50	0,1	5
830	100	0,2	5

632 435 156 *** Byreta Kat.č. 1567/A			
***	Objem (ml)	Delenie (ml)	Balenie (ks)
619	10	0,05	1
723	25	0,1	1
725	50	0,1	1
830	100	0,2	1

Byrety 1567 možno dodať aj v prevedení B, alebo s Schellbachovým pruhom.

632 435 156 *** Byreta, ciachovaná Kat.č. 1567/AC			
***	Objem (ml)	Delenie (ml)	Balenie (ks)
910	10	0,05	1
925	25	0,1	1
950	50	0,1	1

632 435 256 *** Byreta Kat.č. 1567/AT			
***	Objem (ml)	Delenie (ml)	Balenie (ks)
619	10	0,05	1
723	25	0,1	1
725	50	0,1	1
830	100	0,2	1

632 435 256 *** Byreta, ciachovaná Kat.č. 567/ATC			
***	Objem (ml)	Delenie (ml)	Balenie (ks)
910	10	0,05	1
925	25	0,1	1
950	50	0,1	1



632 438 104 000



632 438 112 000



632 438 115 500



632 438 202 000



632 438 810 000



632 435 006 ***



632 435 156 ***

1.1. Laboratórne sklo



632 435 356 ***

632 435 356 *** Byreta			Kat.č. 1571/A
s postranným kohútom, skleneným kladivkom, trieda A			
***	Objem (ml)	Delenie (ml)	Balenie (ks)
619	10	0,05	1
723	25	0,1	1
725	50	0,1	1
830	100	0,2	1

632 435 356 *** Byreta, ciachovaná			Kat.č. 1571/AC
s postranným kohútom, skleneným kladivkom, trieda A			
***	Objem (ml)	Delenie (ml)	Balenie (ks)
910	10	0,05	1
925	25	0,1	1
950	50	0,1	1

632 435 456 *** Byreta			Kat.č. 1571/AVT
s postranným teflonovým ventilom, trieda A			
***	Objem (ml)	Delenie (ml)	Balenie (ks)
619	10	0,05	1
723	25	0,1	1
725	50	0,1	1
830	100	0,2	1

632 435 530 *** Byreta – mikrobyreta podľa Banga			Kat.č. 1591
s rovným kohútom			
***	Objem (ml)	Delenie (ml)	Balenie (ks)
414	1	0,01	1
416	2	0,01	1
517	3	0,02	1
518	5	0,02	1

632 435 540 *** Byreta – mikrobyreta podľa Banga			Kat.č. 1592
s postranným kohútom			
***	Objem (ml)	Delenie (ml)	Balenie (ks)
414	1	0,01	1
416	2	0,01	1
517	3	0,02	1
518	5	0,02	1

632 436 *** *** Fľaša zásobná k automatickej byrete			Kat.č. 2100	
*** ***	Objem (ml)	Sklovina	Kat. č.	Balenie (ks)
801 046	2000	biela	2100/B	6
802 046	2000	hnedá	2100/H	6

332 200 515 134 Balónik k automatickému byrete podľa Pelleta			MaKU
Kompletný s ventilkom a hadičkou			

632 436 *** *** Byreta automatická podľa Pelleta			Kat.č. 1580/BL	
s výpustným kohútom, trieda presnosti B, vrátane zásobnej fľaše a balónika				
*** ***	Objem (ml)	Delenie (ml)	Povolená odchylka (ml)	Balenie (ks)
110 619	10	0,05	0,05	6
110 723	25	0,1	0,1	6
110 725	50	0,1	0,1	6
156 830	100	0,2	0,2	2

632 436 *** *** Byreta automatická podľa Pelleta s výpustným kohútom, trieda presnosti B, bez príslušenstva			Kat.č. 1580/BP	
*** ***	Objem (ml)	Delenie (ml)	Povolená odchylka (ml)	Balenie (ks)
130 619	10	0,05	0,05	2
130 723	25	0,1	0,1	2
130 725	50	0,1	0,1	2
166 830	100	0,2	0,2	2

632 703 *** *** Byreta automatická podľa Pelleta			Kat.č. 1580/BHP	
s výpustným kohútom, hnedé sklo, trieda presnosti B, bez zásobnej fľaše a balónika				
*** ***	Objem (ml)	Delenie (ml)	Povolená odchylka (ml)	Balenie (ks)
420 160	10	0,02	0,03	2
420 170	25	0,05	0,045	2
420 175	50	0,1	0,75	2

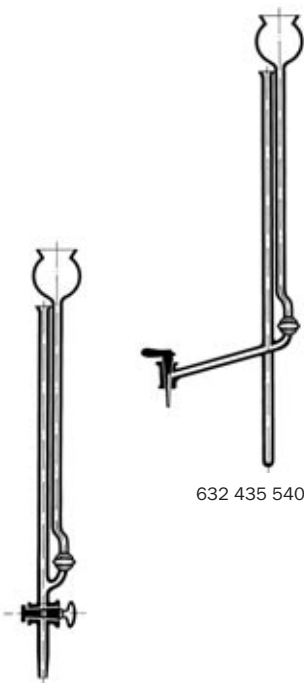

632 435 540 ***

632 435 530 ***



632 436 110 ***

632 436 * *** Byreta automatická podľa Pelleta Kat.č. 1580/BT0**

s výpusným teflonovým ventilom, trieda presnosti B, bez zásobnej fľaše a balónika

*** ***	Objem (ml)	Delenie (ml)	Povolená odchyľka (ml)	Balenie (ks)
366 619	10	0,05	0,05	1
366 723	25	0,1	0,1	1
366 725	50	0,1	0,1	1
366 830	100	0,2	0,2	1

632 436 * *** Byreta automatická podľa Pelleta Kat.č. 1581/BL**

s výpusným a prepúšťacím kohútom, trieda presnosti B, vrátane zásobnej fľaše a pryžového balónika

*** ***	Objem (ml)	Delenie (ml)	Povolená odchyľka (ml)	Balenie (ks)
210 619	10	0,05	0,05	1
210 723	25	0,1	0,1	1
210 725	50	0,1	0,1	1
256 830	100	0,2	0,2	1

632 436 * *** Byreta automatická podľa Pelleta Kat.č. 1581/BP**

s výpusným a prepúšťacím kohútom, trieda presnosti B, bez zásobnej fľaše a balónika

*** ***	Objem (ml)	Delenie (ml)	Povolená odchyľka (ml)	Balenie (ks)
230 619	10	0,05	0,05	2
230 723	25	0,1	0,1	2
230 725	50	0,1	0,1	2
266 830	100	0,2	0,2	2

632 436 * *** Byreta automatická podľa Pelleta Kat.č. 1581/BT0**

s výpusným teflonovým ventilom a prepúšťacím skl. kohútom, trieda presnosti B, bez zásobnej fľaše a balónika

*** ***	Objem (ml)	Delenie (ml)	Povolená odchyľka (ml)	Balenie (ks)
466 619	10	0,05	0,05	2
466 723	25	0,1	0,1	2
466 725	50	0,1	0,1	2
466 830	100	0,2	0,2	2

632 436 * *** Byreta automatická podľa Pelleta, ciachovaná Kat.č. 1581/AS**

s výpusným a prepúšťacím kohútom, Schellbachovým pruhom, trieda presnosti A, vrátane fľaše a balónika

*** ***	Objem (ml)	Delenie (ml)	Balenie (ks)
776 910	10	1:20	1
776 925	25	1:10	1
776 950	50	1:10	1

632 436 * *** Byreta automatická podľa Pelleta Kat.č.1581/ATSO**

s výpusným teflonovým ventilom, Shellbachovým pruhom a prepúšťacím skleneným kohútom, trieda presnosti A, bez fľaše a balónika

*** ***	Objem (ml)	Delenie (ml)	Balenie (ks)
986 619	10	0,05	1
986 723	25	0,1	1
986 725	50	0,1	1

632 436 * *** Byreta automatická podľa Pelleta, ciachovaná Kat.č. 1581/ATS**

s výpusným a prepúšťacím kohútom, Shellbachovým pruhom, trieda presnosti A, vrátane fľaše a balónika

*** ***	Objem (ml)	Delenie (ml)	Balenie (ks)
976 910	10	1:20	1
976 925	25	1:10	1
976 950	50	1:10	1

634 703 * *** Byreta automatická podľa Schillinga**
kalibrácia na úplný výtok, Schellbachový pruh, stupnica popis v čiernej farbe

*** ***	Objem (ml)	Delenie (ml)	Pov.od.(ml)	fľaša (ml)	Balenie (ks)
600 153	5	0,05	0,03	500	1
600 161	10	0,05	0,03	500	1
600 164	15	0,1	0,045	1000	1
600 172	25	0,1	0,045	1000	1
600 175	50	0,1	0,075	1000	1

632 436 210
***

632 436 230 ***

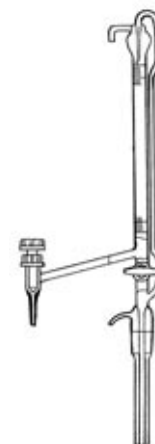

632 436 466 ***



632 436 466 ***



632 436 610 ***

1.1. Laboratórne sklo



632 436 650 825

632 436 610 *** Byreta automatická so samočinným spätným tokom			Kat.č. 1584
***	Objem (ml)	Delenie (ml)	Balenie (ks)
414	1	0,01	1
416	2	0,01	1
518	5	0,02	1
619	10	0,05	1
723	25	0,1	1
725	50	0,1	1

632 436 650 *** Byreta automatická k titračnému stolu		Kat.č. 1590
***	Objem (ml)	Balenie (ks)
719	10	1
723	25	1
825	50	1

Pred objednaním s nami konzultujte typ titračného stola.



632 431 870 ***

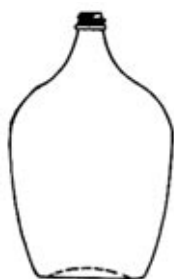

631 059 000 ***

632 431 870 *** Ciachovaný normál (etalon)				Kat.č. 12021
***	Objem (ml)	d (mm)	h (mm)	Balenie (ks)
100	100	51	155	1
200	200	65	195	1
250	250	69,5	211	1
300	300	73,5	223	1
500	500	86	262	2
940	1000	109	330	2
950	2000	135	414	2
960	5000	182,5	563	2
970	10000	226,5	709	1
980	20000	289	905	1

Upozornenie: Normál nie je ciachovaný, len ciachuschný, tj. ciachovanie je nutné objednať samostatne (ide o predmeranú nádobu)!

632 523 102 *** Cievka ženská močová, 2 otvory		Kat.č. 3030
***		Balenie (ks)
000		1

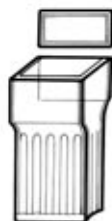

632 499 890 004



632 499 890 001



632 499 890 010



632 499 890 024

631 059 000 *** Demižón sklenený, nepletený		
***	Objem (l)	Bal. (ks)
010	1	1
020	2	1
030	3	1
050	5	1
100	10	1
150	15	1
200	20	1
250	25	1
350	35	1
500	50	1

631 059 000 *** Demižón sklenený, opletený		
***	Objem (l)	Balenie (ks)
011	1	1
021	2	1
031	3	1
051	5	1
101	10	1
151	15	1
201	20	1
251	25	1
351	35	1
501	50	1

634 065 422 100 Zátka kvasná Prebublávajúca do demižóna, s jednou guľičkou	
--	--

632 499 890 *** Dóza na mikrosklá s viečkom				
***	Kat. č.	Typ	Miest	Balenie (ks)
004	2954	Hellendahl	8	10
001	2956	Schiefferdecker	10	10
010	2959	Coplin	5	10
024	2960	Kompletná+vložka	10	10
022	2960/V	vložka do dózy 2960	10	10
023	2960/d	Závesný držiak k vložke		10

632 432 554 * Džbán na moč so stupnicou Kat.č. 3542**

		s uchom a výlevkou		
***	Objem (ml)	d (mm)	h (mm)	Balenie (ks)
845	1500	155	175	4

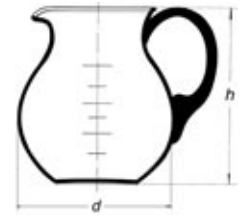

632 432 554 845

632 432 * *** Džbán odmerný valcovitý so stupnicou, s uchom Kat.č. 1681**

***	***	Objem (ml)	d (mm)	h (mm)	Balenie (ks)
511	330	100	50	100	49
511	338	250	68	132	24
511	443	500	83	177	15
511	644	1000	104	205	12
511	746	2000	130	250	6

632 432 * *** Džbán odmerný zvonkovitý s výlevkou a stupnicou Kat.č. 1686**

***	***	Objem (ml)	d ₁ (mm)	d ₂ (mm)	h (mm)	Balenie (ks)
540	818	5	26	20	70	1
540	919	10	30	22	70	1
541	123	25	39	30	90	1
541	125	50	50	38	110	1
541	230	100	62	49	130	1
541	338	250	84	67	160	30
541	443	500	102	80	200	12
541	644	1000	126	100	240	15
541	746	2000	148	116	310	12

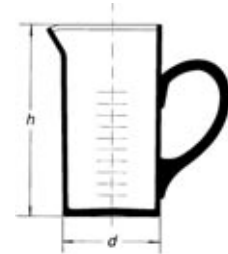

632 432 511 ***

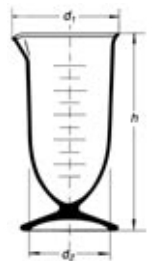

632 432 54* ***

632 432 591 * Džbán odmerný kónický (mensura) so sklenenou patkou a so stupnicou, bez ucha Kat.č. 1688**

***	Objem (ml)	d ₁ (mm)	d ₂ (mm)	h (mm)	Balenie (ks)
123	25	61	45	100	1
225	50	68	54	110	1
230	100	85	65	140	1
338	250	105	75	180	1
443	500	125	80	215	1
544	1000	160	110	270	1
546	2000	192	115	330	1

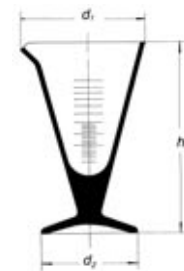

632 432 591 ***

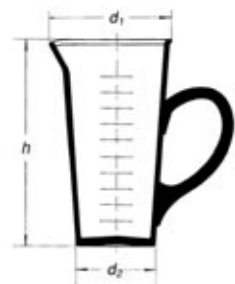

632 432 521 ***

632 432 * *** Džbán odmerný kónický so stupnicou Kat.č. 1683**

***	***	Objem (ml)	d ₁ (mm)	d ₂ (mm)	Balenie (ks)
521	330	100	57	42	49
521	338	250	75	55	24
521	443	500	100	70	15
521	644	1000	120	90	12
521	746	2000	145	107	6

632 415 270 * Exsikátor s plastovým hmatníkom a porcelánovou doskou Kat.č. 262 D**

***	d (mm)	d ₁ (mm)	d ₂ (mm)	Balenie (ks)
100	100	151	90	1
150	150	210	140	1
200	200	269	190	1
250	250	329	240	1
300	300	392	290	1

Dodávame aj časti exsikátora vrátane dosky (dosky vid'. oddiel Lab. porcelán).

632 415 271 * Exsikátor s plastovým hmatníkom skleneným kohútom a porcelánovou doskou Kat.č. 262 D/K**

***	d (mm)	d ₁ (mm)	d ₂ (mm)	Balenie (ks)
100	100	151	90	1
150	150	210	140	1
200	200	269	190	1
250	250	329	240	1
300	300	392	290	1

Dodávame aj časti exsikátora vrátane dosky (dosky vid'. oddiel Lab. porcelán).

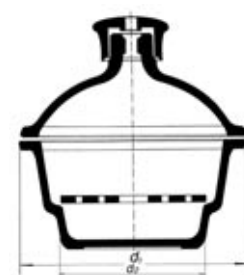

632 415 270 ***

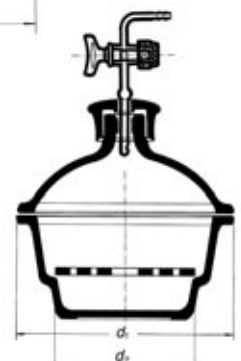

632 415 271 ***

641 333 238 * Doska do exikátora Kat.č. 238**

***	Pre d exikát.(mm)	d ₁ (mm)	d ₂ (mm)	Balenie (ks)
107	100	238/1	90	10
337	150	238/3b	140	10
527	200	238/5a	189	5
827	250	238/8a	241	5
997	300	238/10a	290	5

1.1. Laboratórne sklo

*** **						Náhradné diely k exsikátorom	
*** **		Kat.č.	Názov			Balenie (ks)	
632 441 334 521	263/K/K	Kohút k exsikátoru				1	
321 813 754 000	3754	Hmatník k exsikátoru nevrtaný				1	
321 813 754 010	3754 V	Hmatník k exsikátoru vrtaný				1	
632 921 040 145		Tesniaca vložka k exsikátoru				1	

Filtere so sklenenou fritou

Sklenené fritové filtre sa vyrábajú z presne triedenej drte, z chemicky odolného boritokremičitého skla SIMAX. Sklenená drť sa po vytriedení upravuje do požadovaných tvarov a sintruje. Konečný výrobok je definovaný strednou veľkosťou pórov udávanou v μm a podľa potreby laboratórnej praxe sa vyrába v triedach uvedených v tabuľke. Doštičky je možné zahrievať na teplotu najviac 530°C . Zahrievanie i ochladzovanie musí byť pozvoľné. Pred prvým použitím nového filtra je nutné ním premyť horúcu koncentrovanú kyselinu soľnú a potom chladnú destilovanú vodu, aby sa odstránili prípadné povrchové štepinky a prachové častice. Premýva sa väčším množstvom vody pri silnejšom vákuu. Filter je nutné čistiť ihneď po použití mechanicky (prepláchnutím vodou), prípadne chemicky (čididlom, ktoré zrazeninu rozpustí). Okrem nižšie uvedených výrobkov možno dodať i iné prístroje a zariadenia so sklenenou fritou.

Veľkosť pórov / μm	Značenie	Tlak vody / Pa
160 - 250	S 0	1200 - 1900
90 - 160	S 1	1900 - 3000
40 - 90	S 2	3000 - 7300
15 - 40	S 3	7300 - 18300
5 - 15	S 4	18300 - 75200

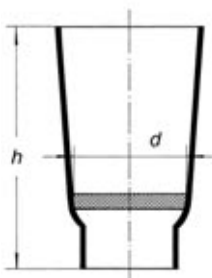

632 424 331 ***

632 424 331 *** Keľímkov filtračný kužeľového tvaru					Kat.č. 31 S
***	Objem (ml)	d (mm)	h (mm)	Pórovitosť	Balenie (ks)
002	15	20	50	S 0	1
102	15	20	50	S 1	1
202	15	20	50	S 2	1
302	15	20	50	S 3	1
402	15	20	50	S 4	1
103	35	30	60	S 1	1
203	35	30	60	S 2	1
303	35	30	60	S 3	1
403	35	30	60	S 4	1
104	55	40	65	S 1	1
204	55	40	65	S 2	1
304	55	40	65	S 3	1
404	55	40	65	S 4	1

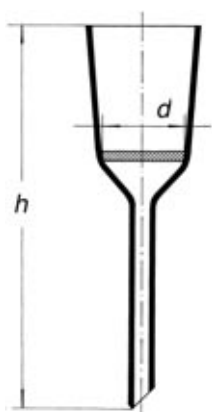

632 424 334 ***

632 424 334 *** Nuč s rovnou fritou					Kat.č. 34 S
***	Priemer (mm)	h (mm)	Pórovitosť	Balenie (ks)	
103	30	143	S 1	1	
203	30	143	S 2	1	
303	30	143	S 3	1	
403	30	143	S 4	1	
104	40	165	S 1	1	
204	40	165	S 2	1	
304	40	165	S 3	1	
404	40	165	S 4	1	
106	60	195	S 1	1	
206	60	195	S 2	1	
306	60	195	S 3	1	
406	60	195	S 4	1	
109	90	245	S 1	1	
209	90	245	S 2	1	
309	90	245	S 3	1	
409	90	245	S 4	1	
112	120	310	S 1	1	
212	120	310	S 2	1	
312	120	310	S 3	1	
412	120	310	S 4	1	
115	150	425	S 1	1	
215	150	425	S 2	1	
315	150	425	S 3	1	
415	150	425	S 4	1	
117	175	490	S 1	1	
217	175	490	S 2	1	
317	175	490	S 3	1	
417	175	490	S 4	1	
121	210	575	S 1	1	
221	210	575	S 2	1	
321	210	575	S 3	1	
421	210	575	S 4	1	

632 442 285 *** Premývačka obojstranná						Kat.č. 85 S
***	Objem (ml)	NZ	d (mm)	h (mm)	Pórovitosť	Balenie (ks)
103	30	19/26	10	215	S 1	1
110	100	29/32	20	315	S 1	1

632 442 281 *** Premývačka s fritovým nástavcom						Kat.č. 81 S
***	Objem (ml)	NZ	d (mm)	h (mm)	Pórovitosť	Balenie(ks)
102	100	29/32	20	250	S 1	1
202	100	29/32	20	250	S 2	1
103	250	45/40	30	250	S 1	1
203	250	45/40	30	250	S 2	1

632 426 201 *** Premývačka podľa Drechslera s NZ 29/32						Kat.č. 2450
***	Objem (ml)	d (mm)	h (mm)	h ₁ (mm)	Balenie (ks)	
100	100	8	250	200	1	
250	250	8	250	200	1	
500	500	8	250	200	1	
940	1000	8	250	200	1	

Samostatne dodávame fľašu i nástavec

632 414 *** *** Fľaša reagenčná						Kat.č. 2002/B
úzkohrdlá so zabrušenou zátkou, číra						
*** ***	Objem (ml)	d (mm)	h (mm)	NZ	Balenie (ks)	
102 050	50	41,5	77	14/15	48	
102 100	100	51,5	103	14/23	70	
102 250	250	69	131	19/26	30	
102 500	500	85	163	24/29	15	
102 940	1000	106,5	199	29/32	12	
102 950	2000	132	245	29/32	6	
142 956	5000	181	325	45/40	3	
142 966	10000	227	403	60/46	1	

632 414 *** *** Fľaša reagenčná						Kat.č. 2002/H
úzkohrdlá so zabrušenou zátkou, hnedá						
*** ***	Objem (ml)	d (mm)	h (mm)	NZ	Balenie (ks)	
202 050	50	41,5	77	14/15	48	
202 100	100	51,5	103	14/23	70	
202 250	250	69	131	19/26	30	
202 500	500	85	163	24/29	15	
202 940	1000	106,5	199	29/32	12	
202 950	2000	132	245	29/32	6	

632 414 *** *** Fľaša širokohrdlá						Kat.č. 2006/B
(prachovnica) so zabrušenou zátkou, číra						
***	Objem (ml)	d (mm)	h (mm)	NZ	Balenie (ks)	
104 050	50	41,5	76	24/20	40	
104 100	100	51,5	95	29/22	48	
104 250	250	69	128	34/24	30	
104 500	500	85	162	45/27	15	
104 940	1000	106,5	187	60/31	12	
104 950	2000	132	238	60/31	6	
144 956	5000	181	338	85/55	3	
144 966	10000	227	427	85/55	1	

632 414 *** *** Fľaša širokohrdlá						Kat.č. 2006/H
(prachovnica) so zabrušenou zátkou, hnedá						
***	Objem (ml)	d (mm)	h (mm)	NZ	Balenie (ks)	
204 050	50	41,5	76	24/20	40	
204 100	100	51,5	95	29/22	48	
204 250	250	69	128	34/24	30	
204 500	500	85	162	45/27	15	
204 940	1000	106,5	187	60/31	12	
204 950	2000	132	238	60/31	6	

632 414 112 *** Fľaša hranatá, číra						Kat.č. 2043/B
širokohrdlá so zabrušenou zátkou						
***	Objem (ml)	A (mm)	B (mm)	h (mm)	NZ	Balenie (ks)
100	100	51	51	103	29/22	48
150	150	70,5	51,5	103	29/22	18
250	250	70	50	143	29/22	42
350	350	71,5	71,5	153	34/24	30
500	500	92	71,5	148	34/24	24
750	750	90	71,5	237	45/27	15

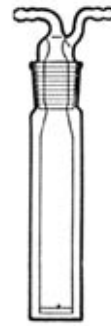

632 442 285 ***

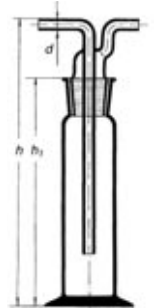

632 426 201 100

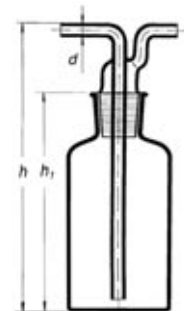

632 426 201 500

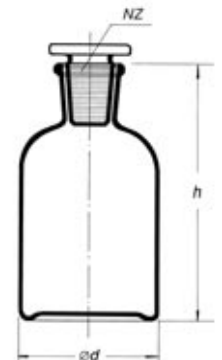

632 414 102 ***

632 414 202 ***

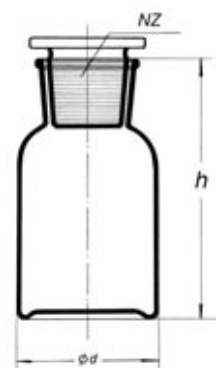

632 414 104 ***

632 414 204 ***

1.1. Laboratórne sklo

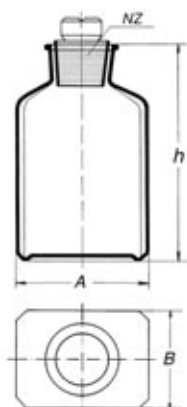

632 414 112 ***
632 414 212 ***

632 414 212 *** Fľaša hranatá, hnedá Kat.č. 2043/H

širokohrdlá so zbrúsenou zátkou						
***	Objem (ml)	A (mm)	B (mm)	h (mm)	NZ	Balenie (ks)
100	100	51	51	103	29/22	48
150	150	70,5	51,5	103	29/22	18
250	250	70	50	143	29/22	42
350	350	71,5	71,5	153	34/24	30
500	500	92	71,5	148	34/24	24
750	750	90	71,5	237	45/27	15

632 414 126 *** Fľaša úzkohrdlá reagenčná Steilbrust, číra Kat.č. 2010/B

so zbrúsenou zátkou					
***	Objem (ml)	d (mm)	h (mm)	NZ	Balenie (ks)
050	50	41,5	77	14/15	48
100	100	51,5	103	14/23	48
250	250	69	131	19/26	30
500	500	85	163	24/29	9
940	1000	106,5	199	29/32	12
950	2000	133	245	29/32	6

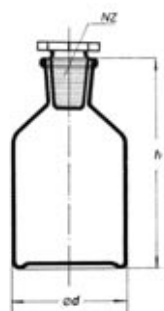

632 414 126 ***

632 414 226 *** Fľaša úzkohrdlá reagenčná Steilbrust, hnedá Kat.č. 2010/H

so zbrúsenou zátkou					
***	Objem (ml)	d (mm)	h (mm)	NZ	Balenie (ks)
050	50	41,5	77	14/15	48
100	100	51,5	103	14/23	48
250	250	69	131	19/26	30
500	500	85	163	24/29	9
940	1000	106,5	199	29/32	12
950	2000	133	245	29/32	6

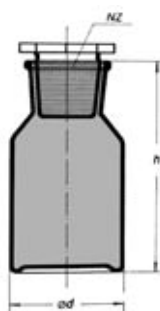

632 414 227 ***

632 414 127 *** Fľaša širokohrdlá prachovnica Steilbrust, hnedá Kat.č. 2014/B

so zbrúsenou zátkou					
***	Objem (ml)	d (mm)	h (mm)	NZ	Balenie (ks)
050	50	41,5	76	24/20	48
100	100	51,5	95	29/22	48
250	250	69	128	34/24	30
500	500	85	162	45/27	9
940	1000	106,5	197	60/46	12
950	2000	133	248	60/46	6

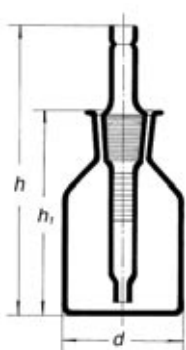

632 425 020 ***

632 414 227 *** Fľaša širokohrdlá prachovnica Steilbrust, hnedá Kat.č. 2014/H

so zbrúsenou zátkou					
***	Objem (ml)	d (mm)	h (mm)	NZ	Balenie (ks)
050	50	41,5	76	24/20	48
100	100	51,5	95	29/22	48
250	250	69	128	34/24	30
500	500	85	162	45/27	9
940	1000	106,5	197	60/46	12
950	2000	133	248	60/46	6

632 425 020 *** Fľaša indikátorová Kat.č. 2016/B

so zbrúsenou pipetkou a NZ, číra						
***	Objem (ml)	d (mm)	h (mm)	h ₁ (mm)	NZ	Balenie (ks)
050	50	42	107	77	14/15	30
100	100	52	133	103	14/23	30
250	250	70	161	131	19/26	30

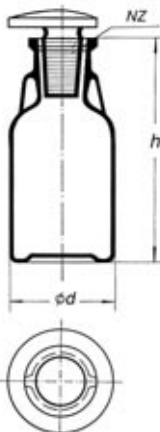

632 425 020 ***

632 425 023 *** Fľaša indikátorová Kat.č. 2016/H

so zbrúsenou pipetkou a NZ, hnedá						
***	Objem (ml)	d (mm)	h (mm)	h ₁ (mm)	NZ	Balenie (ks)
050	50	42	107	77	14/15	30
100	100	52	133	103	14/23	30
250	250	70	161	131	19/26	30

632 414 109 *** Fľaša kvapkacia, číra Kat.č. 2020/B

so zbrúsenou zátkou					
***	Objem (ml)	d (mm)	h (mm)	NZ	Balenie (ks)
050	50	44	92	14/23	96
100	100	55	106	14/23	70

632 414 209 *** Fľaša kvapkacia, hnedá Kat.č. 2020/H

so zbrúsenou zátkou					
***	Objem (ml)	d (mm)	h (mm)	NZ	Balenie (ks)
050	50	44	92	14/23	96
100	100	55	106	14/23	70

632 426 001 *** Fľaša kvapkacia číra, s výmennou zátkou, NZ			Kat.č. 3130/B
***	Objem (ml)	NZ	Balenie (ks)
150	150	29/32	1
250	250	29/32	1
500	500	29/32	1



632 426 001 ***

632 426 005 *** Fľaša kvapkacia podľa Schustera (undinka) so zátkou NZ 10/15			Kat.č. 2018
***	Objem (ml)	d (mm)	Balenie (ks)
050	50	47	1
100	100	58	1
250	250	75	1



632 426 005 ***

632 411 502 *** Fľaša na kultúry podľa Rouxa, hrdlo v strede						Kat.č. 70
***	Objem (ml)	d (mm)	l (mm)	l ₁ (mm)	h (mm)	Balenie (ks)
100	75	20	60	25	125	24
300	250	25	80	35	180	16
500	450	30	95	42	195	14
942	1000	32	120	55	255	6
950	2000	40	150	70	320	5

Možno dodať v prevedení s hrdlom na strane, kat. č. 70A.

632 411 507 *** Fľaša na kultúry podľa Rouxa, hrdlo v strede tvarované na NZ						Kat.č. 70/T
***	Objem (ml)	NZ	l (mm)	l ₁ (mm)	h (mm)	Balenie (ks)
100	75	14/15	60	25	125	24
300	250	19/17	80	35	180	16
500	450	24/20	95	42	195	14
942	1000	24/20	120	55	255	6

Možno dodať v prevedení s hrdlom, tvarovaným na NZ, kat. č. 70A/T.



632 411 507 ***

632 411 510 *** Fľaša kultivačná podľa Blacka hrdlo tvarované na NZ						Kat.č. 3120
***	Objem (ml)	l (mm)	l ₁ (mm)	h (mm)	NZ	Balenie (ks)
200	200	45	45	175	24/20	12
151	150	45	45	155	24/20	12

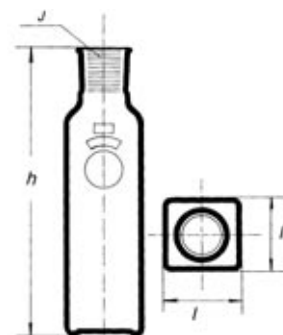

632 411 510 200

632 415 046 *** Fľaša podľa Wouffa so zabrúsenou zátkou a kohútom pri dne, NZ				Kat.č. 2038
***	Objem (ml)	NZ ₁ (mm)	NZ ₂ (mm)	Balenie (ks)
500	500	19/26	19/26	4
940	1000	24/29	19/26	4
950	2000	29/32	19/26	3
956	5000	45/40	24/29	3
966	10000	50/42	29/32	1
967	15000	50/42	29/32	1
968	20000	50/42	29/32	1

Pred použitím je nutné premasovať, alebo namočiť kohút.

Možno dodať prevedenie s dvomi a tromi hrdlami bez výpusti (Kat. č. 2032, Kat. č. 2030), prevedenie trojhrdlé so spodnou výpusťou (Kat. č. 2034) a samostatný kohút podľa zábrusu NZ₂.



632 415 046 ***

632 447 702 *** Fľaša - kyslíkovka (podľa Winklera) šikmá zátka, matovaný štítok, presne označený objem			Kat.č. 2772/a
***	Objem (ml)	NZ	Balenie (ks)
154	100 - 150	14,5/23	1
303	250 - 300	19/26	1

632 414 321 *** Fľaša reagenčná s modrým uzáverom uzáver a vylievací krúžok z PP- odolnosť do 140 °C					Kat.č. 2070/M
***	Objem (ml)	GL (mm)	d (mm)	h (mm)	Balenie (ks)
100	100	45	56	105	10
250	250	45	70	143	10
500	500	45	86	182	10
940	1000	45	101	203	10
950	2000	45	130	268	10
956	5000	45	186	355	6
966	10000	45	234	435	1
968	20000	45	234	435	1

1.1. Laboratórne sklo

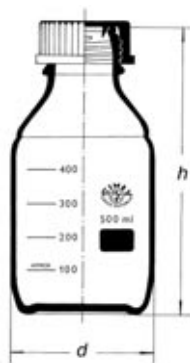

632 414 321 ***

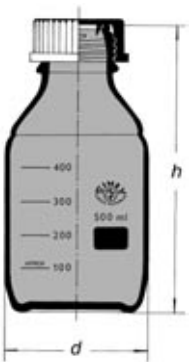

632 414 606 ***



634 993 659 ***



632 828 061 103



632 828 041 102



632 436 802 046

632 414 321 *** Fľaša reagenčná s červeným uzáverom Kat.č. 2070/R

uzáver a vylievací krúžok z PP- odolnosť do 180 °C

***	Objem (ml)	GL (mm)	d (mm)	h (mm)	Balenie (ks)
101	100	45	56	105	10
251	250	45	70	143	10
501	500	45	86	182	10
941	1000	45	101	203	10
951	2000	45	130	268	10
957	5000	45	186	355	6
967	10000	45	234	435	1
969	20000	45	234	435	1

632 993 606 *** Fľaša reagenčná s modrým uzáverom, hnedá Kat.č. 2070/H

uzáver a vylievací krúžok z PP- odolnosť do 140 °C

***	Objem (ml)	GL (mm)	d (mm)	h (mm)	Balenie (ks)
505	100	45	56	105	10
506	250	45	70	143	10
507	500	45	86	182	10
508	1000	45	101	203	10
509	2000	45	130	268	10
512	5000	45	186	355	6

632 414 322 *** Fľaša so šrobovým uzáverom z PP s otvorom Kat.č. 2070/MO

a gumovou zátkou

***	Objem (ml)	d (mm)	h (mm)	Balenie (ks)
100	100	56	105	10
250	250	70	143	10
500	500	86	182	10
940	1000	101	203	10

Vhodná pre aplikácie, na ktoré sa v minulosti používali fľaše JUS a NTS. Fľaše dodávame kompletne, alebo iba samostatne zátky. Ponuku môžeme rozšíriť až do objemu 20 l.

332 100 004 *** Zátka gumová, čierná

***	Balenie (ks)
742	Zátka je určená na jedno použitie 1

634 993 659 *** Fľaša reagenčná štvorhranná Kat.č. 2071/M

s modrým uzáverom, čiara

***	Objem (ml)	GL (mm)	Uzáver (ml)	Výška (mm)	Balenie (ks)
205	100	50	32	101	10
206	250	64	45	143	10
207	500	78	45	181	10
208	1000	95	45	222	10

634 *** *** *** Fľaša zásobná so závitom GL 45, vrátane uzáveru, hnedá

uzáver z PP-odolnosť do 140 °C, k dávkovačom a digitálnym byretám

*** *** ***	Objem (ml)	NZ	Balenie (ks)
709 390 114	1400 s bočným nalievacím hrdlom	45	1
709 390 125	2500 s bočným nalievacím hrdlom	45	1
993 620 610	2500 bez bočného nalievacieho hrdla	45	1

634 993 620 *** Fľaša zásobná štvorhranná so závitom GL 45, vrátane uzáveru hnedá

uzáver z PP-odolnosť do 140 °C, k dávkovačom a digitálnym byretám

***	Objem (ml)	NZ	Balenie (ks)
606	250	1	1
607	500	1	1
608	1000	1	1

632 *** *** *** Fľaša kojenecká

sacia, závitová so silikonovým dudlíkom - savička

*** *** ***	Objem (ml)	Typ	Kat. č.	Balenie (ks)
828 041 102	220	so závesným ramienkom	8205	48
828 061 103	125	s potiskom, kompletná	8235	54
827 090 103	125	s potiskom, náhradné sklo	8225	54
828 112 003	250	s potiskom, kompletná	8305	54
827 510 503	250	s potiskom, náhradné sklo	8295	54
828 102 002	250	s reliéfom, kompletná	8265	54
827 510 402	250	s reliéfom, náhradné sklo	8255	54

632 436 *** *** Fľaša zásobná k automatickej byrete Kat.č. 2100

*** ***	Objem (ml)	Sklovina	Kat. č.	Balenie (ks)
801 046	2000	čiara	2100/B	6
802 046	2000	hnedá	2100/H	6

632 936 992 *** Fľaša na kyselinu, číra				Kat.č. 2127/B
so zaobrubenou zátkou a zaobrubeným klobúčikom				
***	Objem (ml)	d (mm)	h (mm)	Balenie (ks)
055	100	55	145	10
065	250	75	180	10
075	500	82	220	10
085	1000	109	260	10



632 936 992 ***

632 936 993 *** Fľaša na kyselinu, hnedá				Kat.č. 2127/H
so zaobrubenou zátkou a zaobrubeným klobúčikom				
***	Objem (ml)	d (mm)	h (mm)	Balenie (ks)
055	100	55	145	10
065	250	75	180	10
075	500	82	220	10
085	1000	109	260	10

632 *** *** *** Fľaša odsávací s plastovou olivkou					Kat.č. 2419			
***	***	***	Objem (ml)	d ₁ (mm)	d ₂ (mm)	h (mm)	Balenie (ks)	
412	021	100	100	70	24	105	10	
412	021	250	250	85	35	145	10	
412	021	500	500	105	35	175	8	
412	021	940	1000	135	45	230	8	
412	021	950	2000	165	60	255	6	
412	021	952	3000	NT	170	70	295	1
412	021	956	5000	NT	185	80	360	1
412	021	966	10000	NT	240	80	420	1
321	194	885	15000	NT	255	75	500	1
321	194	915	20000	NT	290	75	535	1

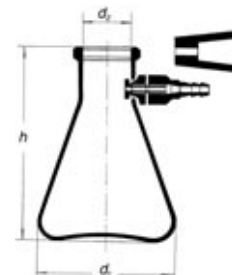

632 412 021 ***

63* *** *** *** Fľaša odsávací so sklenenou olivkou					Kat.č. 2420				
*	***	***	***	Objem (ml)	d ₁ (mm)	d ₂ (mm)	h (mm)	Balenie (ks)	
2	412	022	100	100	70	24	105	10	
2	412	022	250	250	85	35	145	10	
2	412	022	500	500	105	35	175	8	
2	412	022	940	1000	135	45	230	8	
2	412	022	950	2000	165	60	255	6	
2	412	022	952	3000	NT	170	70	295	1
2	412	022	956	5000	NT	185	80	360	1
2	412	022	966	10000	NT	240	80	420	1
4	302	119	188	15000	NT	255	75	500	1
4	302	119	191	20000	NT	290	75	535	1

* NT = nový tvar (valcovitý)

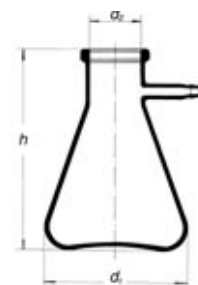

632 412 022 ***

632 511 101 *** Fľaša zásobná na injekčné séra					Kat.č. 3125
***	Objem (ml)	d (mm)	h (mm)	NZ	Balenie (ks)
100	100	50	115	29/32	24
250	250	68	145	34/35	10
500	500	83	165	34/35	10
940	1000	105	197	34/35	10
950	2000	125	257	34/35	3
956	5000	178	305	34/35	2
966	10000	220	385	34/35	1
968	20000	286	470	60/46	1

Možno dodať prevedenie s graduáciou, Kat. č. 3126.

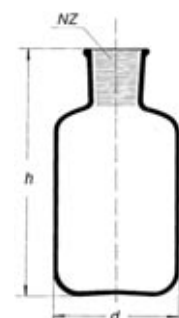

632 511 101 ***

635 038 0** *** Fľaša úzkohrdlá so závitom - liekovka					
**	***	Objem(ml)	Farba	Na uzáver	Balenie (ks)/paleta(ks)
40	500	10	hnedá	GL 18	224/22848
40	052	25	hnedá	GL 18	168/12096
40	000	50	hnedá	GL 18	110/6600
40	005	100	hnedá	PP 28	475/4750
40	060	200	číra	GL 28	56/3360
40	061	300	hnedá	PP 28	259/2590
40	063	500	hnedá	PP 28	208/1456
40	080	1000	hnedá	PP 28	130/780



635 038 0** ***

635 *** *** *** Fľaša širokohrdlá so závitom - tabletovka						
**	***	Objem(ml)	Farba	Na uzáver	Balenie (ks)/paleta(ks)	
038	040	224	50	hnedá	GL 32	99/6534
414	420	851	75	hnedá	GL 40	48/5592
414	323	001	300	hnedá	GL 50	30/1935
414	328	001	800	hnedá	GL 60	15/1000
414	323	002	1300	hnedá	GL 60	12/536



632 414 *** ***

1.1. Laboratórne sklo

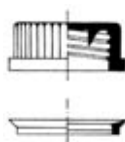

635 414 *** *** Uzáver k liekovkám a tabletkám			
***	Priemer (mm)	Uzáver	Balenie (ks)
041 040	18	GL 18	1
000 761	28	PP 28 (331039000761)	1
041 042	28	GL 28	1
041 043	32	GL 32	1
041 044	40	GL 40	1
041 045	50	GL 50	1
041 046	60	GL 60	1



634 002 ***

634 002 *** *** Fľaštička na kvapky s GL 18, hnedá		
***	Objem (ml)	Balenie (ks)
050 002	10	204
050 004	20	150
050 006	30	112
050 008	50	80

634 002 *** Uzáver a príslušenstvo k fľaštičkám na kvapky		
*** ***	Špecifikácia	Balenie (ks)
050 100	Uzáver s tesnením	1
050 101	Uzáver s vnútorným kvapátkom	1
050 110	Kvapátko na očné kvapky - Sterilné	1
050 122	Uzáver s pipetkou na 10 ml	1
050 124	Uzáver s pipetkou na 20 ml	1
050 126	Uzáver s pipetkou na 30 ml	1
050 128	Uzáver s pipetkou na 50 ml	1

Technické sklenené guľičky

Technické guľičky z vysoko kvalitného skla nachádzajú široké uplatnenie v mnohých priemyselných odvetviach a používajú sa najmä ako:

- Mlecie médium perlových mlynov
- Náplne filtračných zariadení
- Materiál na opracovanie kovov, dreva a plastov
- Špeciálne náplne do chemických aparatúr

Guľičky sú pre menované odvetvia zvlášť vhodné pre ich neškodné chemické zloženie a zdravotnú nezávadnosť.

Miera hustoty guľičiek umožňuje ich použitie v mlynoch pre média s nízkou a strednou viskozitou. Ich použitie dáva tiež vynikajúce výsledky v mlynoch spracovávajúcich vysoko viskózne produkty.

Technológia výroby zaručuje takmer dokonalý guľový tvar a starostlivo kontrolované priemery. Guľičky sú chemicky a tepelne upravené pre zaistenie vysokého lesku a mimoriadne odolné proti nárazu a oteru.



632 645 *** ***

Fyzikálne a chemické vlastnosti

Špecifická hmotnosť: 2500-40 kg/m³
 Koeficient tepelnej rozťažnosti: 9,1x10⁻⁶ K⁻¹

Sypká hmotnosť: 1 485 kg/m³

Tvrdosť podľa Mohse: 6

Tvrdosť podľa Vickersa a Rockwella: 970-1018 kp/cm²

Model pružnosti: 7,75 MPa

Model pružnosti E podľa Younga: 78-85 GPa

Hydrolytická trieda: III.

Odolnosť proti kyselinám: III.

Odolnosť proti hydroxidom: A-1

Balenie:

PE sáčky po 1 kg
 textilné a polypropylénové dvojité vedrá s obsahom 25 kg
 Drevené bedne obsahujúce 500 kg guľičiek (20 vriec po 25 kg)
 Štandardná paleta 800x1200 mm s jednou alebo dvoma bedňami (500 alebo 1000 kg)

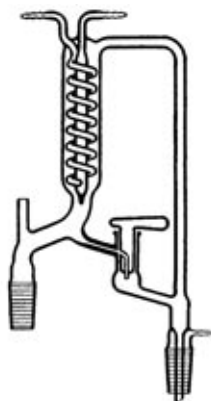

632 441 242 ***

632 645 *** *** Guľička technická, sklenená				
*** ***	Priemer (mm)	Pevnosť v tlaku (N)	Kontaktný povrch (cm ³)	Ks/kg
101 500	1,5±0,2	600	15 990	226 350
102 000	2±0,2	900	11 990	95 500
102 500	2,5±0,2	1 100	9 600	48 900
103 000	3±0,2	1 700	8 000	28 300
103 500	3,5±0,3	1 800	6 850	17 800
104 000	4±0,3	2 300	6 000	11 940
104 500	4,5±0,3	2 400	5 350	8 390
105 000	5±0,3	2 600	4 800	6 110
106 000	6±0,3	3 600	4 000	3 540
107 000	7±0,3	3 800	3 400	2 230
108 000	8±0,4	6 200	3 000	1 500
109 000	9±0,4	8 000	2 660	1 050
110 000	10±0,5	8 400	2 400	760

632 441 242 *** Hlava destilačná pre odber reflexu s kohútom a NZ 14/23 pre teplomer			Kat.č. 8736
***	NZ (mm)	Balenie (ks)	
050	14/23	1	
080	29/32	1	

632 441 246 ***	Hlava destilačná na malé množstvá	Kat.č. 8739
***	NZ (mm)	Balenie (ks)
050	14/23	1

634 850 006 ***	Homogenizátor s teflónovým piestom			
***	Medzera medzi valcom a piestom: 0,15-0,25 mm			
***	Objem (ml)	Rozmery valca (mm)	Dĺžka piestu (mm)	Balenie (ks)
Hmoždír:				
102	2	8x120		1
105	5	12x132		1
110	10	15x150		1
115	15	19x155		1
130	30	25x175		1
150	50	32x192		1
Piest:				
302	2		230	1
305	5		235	1
310	10		270	1
315	15		270	1
330	30		270	1
350	50		270	1

634 666 029 ***	Mikrohomogenizátor				
***	Mikroskúmavky s guľičkovým skleneným zabrúseným piestom. Pre roztieranie a homogenizovanie malých objemov tkanív.				
***	Typ	Objem (µl)	Dĺžka (mm)	Vnútorňý Ø (mm)	Balenie (ks)
651	G1	10-25	30	cca 4	1
751	G2	25-100	40	cca 6	1
851	G3	100-1000	50	cca 8	1

634 666 198 ***	Homogenizátor podľa Dounce				
***	Pre homogenizáciu buniek bez poškodenia jadra. Leštený povrch skúmavky a skleneného piestu. Dva piesty v každej sade s rôznou medzerou medzi piestom a stenou valca - voľný piest pre počiatočnú fázu homogenizovania - tesný piest pre kompletnú homogenizáciu.				
***	Objem (ml)	Medzera (mm) voľný piest	Medzera (mm) tesný piest	Dĺžka (mm) skúmavky	Balenie (ks)
402	2	0,075-0,125	0,013-0,064	60	1
407	7	0,070-0,118	0,020-0,056	125	1
415	15	0,087-0,162	0,025-0,075	157	1
440	40	0,075-0,150	0,025-0,075	215	1
500	100	0,050-0,250	0,013-0,138	232	1

632 442 505 ***	Chladič podľa Liebiga bez zábrusu		Kat.č. 7110
***	l (mm)	d (mm)	Balenie (ks)
200	200	24	1
300	300	24	1
400	400	24	1
500	500	24	1
700	700	32	1
990	1000	32	1

632 442 506 ***	Chladič podľa Liebiga s NZ jadrom		Kat.č. 8251
***	NZ	l (mm)	d (mm)
202	14/23	200	24
205	29/32	200	24
302	14/23	300	24
305	29/32	300	24
402	14/23	400	24
405	29/32	400	24
705	29/32	700	32
995	29/32	1000	32

632 442 507 ***	Chladič podľa Liebiga s dvoma NZ		Kat.č. 8252
***	NZ	l (mm)	d (mm)
202	14/23	200	24
205	29/32	200	24
305	29/32	300	24
402	14/23	400	24
405	29/32	400	24
705	29/32	700	32
995	29/32	1000	32



634 850 006 ***



634 666 029 ***

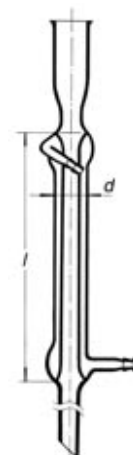

632 442 505 ***

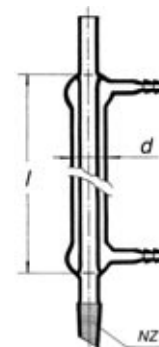

632 442 506 ***

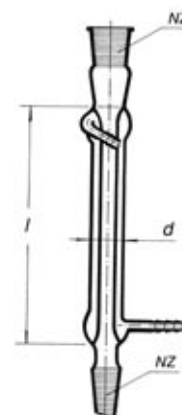

632 442 507 ***

1.1. Laboratórne sklo

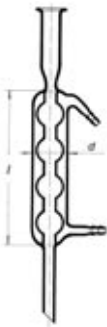

632 442 511 ***

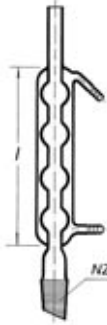

632 442 512 ***

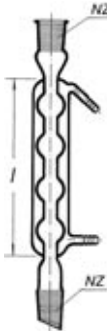

632 442 513 ***

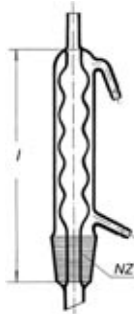

632 442 531 ***

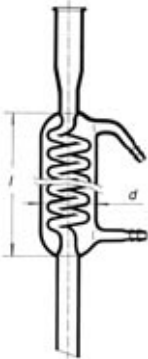

632 442 515 ***

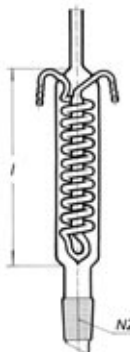

632 442 516 ***

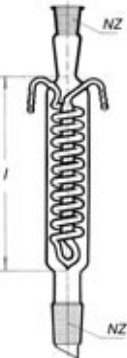

632 442 517 ***



632 442 532 ***

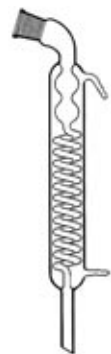

632 442 518 ***

632 442 511 *** Chladič guľičkový podľa Allihna bez zábrusu Kat.č. 7114

***	l (mm)	d (mm)	Guľičiek	Balenie (ks)
200	200	40	4	1
300	300	40	6	1
400	400	40	8	1
600	600	40	12	1
800	800	40	16	1

632 442 512 *** Chladič guľičkový podľa Allihna s NZ jadrom Kat.č. 8256

***	NZ	l (mm)	Guľičiek	Balenie (ks)
202	14/23	200	4	1
205	29/32	200	4	1
302	14/23	300	6	1
305	29/32	300	6	1
402	14/23	400	8	1
405	29/32	400	8	1
605	29/32	600	13	1

632 442 513 *** Chladič guľičkový podľa Allihna s dvoma NZ Kat.č. 8257

***	NZ	l (mm)	Guľičiek	Balenie (ks)
202	14/23	200	4	1
205	29/32	200	4	1
302	14/23	300	6	1
305	29/32	300	6	1
402	14/23	400	8	1
405	29/32	400	8	1
605	29/32	600	13	1

632 442 531 *** Chladič guľičkový k extraktoru (Soxhlet) Kat.č. 8281

***	Objem (ml)	NZ	l (mm)	Guľičiek	Balenie (ks)
030	30	29/32	200	4	1
070	70	34/35	200	4	1
100	100	45/40	300	5	1
200	200	55/50	300	5	1
500	500	60/46	400	7	1
940	1000	71/51	400	7	1

632 442 515 *** Chladič špirálový bez zábrusu Kat.č. 7112

***	l (mm)	d (mm)	Závitov	Balenie (ks)
200	200	40	9	1
300	300	40	15	1
400	400	40	22	1
500	500	40	28	1
600	600	40	35	1

632 442 516 *** Chladič špirálový podľa Dimrotha s NZ Kat.č. 8260

***	NZ	l (mm)	Závitov	Balenie (ks)
202	14/23	200	11	1
205	29/32	200	11	1
302	14/23	300	18	1
305	29/32	300	18	1
405	29/32	400	26	1
605	29/32	600	40	1

632 442 517 *** Chladič špirálový podľa Dimrotha s dvoma NZ Kat.č. 8261

***	NZ	l (mm)	Závitov	Balenie (ks)
202	14/23	200	11	1
205	29/32	200	11	1
302	14/23	300	18	1
305	29/32	300	18	1
405	29/32	400	26	1
605	29/32	600	40	1

632 442 532 *** Chladič špirálový podľa Dimrotha pre extraktory Kat.č. 8282

***	Objem (ml)	NZ	l (mm)	Závitov	Balenie (ks)
070	70	34/35	200	18	1
100	100	45/40	300	23	1
200	200	55/50	300	23	1
500	500	60/46	400	32	1
940	940	71/51	400	32	1

632 442 518 *** Chladič špirálový so šikmým prívodom v uhle 75° Kat.č. 8262

***	NZ	l (mm)	Balenie (ks)
305	29/32	300	1
405	29/32	400	1

632 442 519 *** Chladič špirálový so zabrúseným plášťom			Kat.č. 8275
***	NZ	l (mm)	Balenie (ks)
202	14/23	200	1
302	14/23	300	1
305	29/32	300	1
405	29/32	400	1

632 442 520 *** Chladič špirálový na práce pri zníženom tlaku			Kat.č. 8725
***	NZ	l (mm)	Balenie (ks)
305	29/32	300	1
405	29/32	400	1

632 442 508 *** Chladič špirálový podľa Westa s dvoma NZ					Kat.č. 8253
***	NZ	l (mm)	d (mm)	Závitov	Balenie (ks)
205	29/32	200	24	8	1
305	29/32	300	24	13	1
405	29/32	400	24	18	1
705	29/32	700	24	33	1
995	29/32	1000	24	48	1

632 442 *** *** Chladič spätný skrutkový podľa Friedrichsa						Kat.č. 8265,8266
***	***	Kat. č.	NZ	l (mm)	Prevedenie	Balenie (ks)
525	050	8265	14/23	200	s bočným prívodom	1
525	080	8265	29/32	220	s bočným prívodom	1
526	080	8266	29/32	250	so šikmou odbočkou	1

632 415 623 *** Irigátor súdkovitý s vekom, kohútom a tubusom pri dne					Kat.č. 827/R
***	Objem (ml)	d (mm)	NZ	Balenie (ks)	
952	3000	100	29/32	1	
956	5000	100	29/32	1	
966	10000	127	29/32	1	
968	20000	160	34/35	1	

632 *** *** *** Kadička nízka s výlevkou					Kat.č. 155	
***	***	***	Objem (ml)	d (mm)	h (mm)	Balenie (ks)
411	010	005	5	22	30	10
411	010	010	10	26	35	10
411	010	025	25	34	50	10
411	010	050	50	42	60	10
417	010	100	100	50	70	10
417	010	150	150	60	80	10
417	010	250	250	70	95	10
417	010	400	400	80	110	10
417	010	600	600	90	125	10
417	010	800	800	100	135	10
417	010	940	1000	105	145	10
417	010	950	2000	130	185	4
411	010	952	3000	150	210	4
411	010	956	5000	170	270	2
411	010	966	10000	217	350	1

632 *** *** *** Kadička vysoká s výlevkou					Kat.č. 153	
***	***	***	Objem (ml)	d (mm)	h (mm)	Balenie (ks)
411	012	025	25	30	55	10
411	012	050	50	38	70	10
417	012	100	100	48	80	10
417	012	150	150	54	95	10
417	012	250	250	60	120	10
417	012	400	400	70	130	10
417	012	600	600	80	150	10
417	012	800	800	90	175	10
417	012	940	1000	95	180	10
417	012	950	2000	120	240	6
411	012	952	3000	135	280	6

632 411 008 *** Kadička cukrovárnica					Kat.č. 165
***	Objem (ml)	d (mm)	d ₁ (mm)	h (mm)	Balenie (ks)
200	200	71	64	100	24
300	300	80	73	115	12



632 442 519 ***



632 442 520 ***

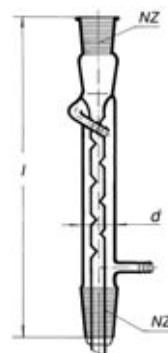

632 442 508 ***

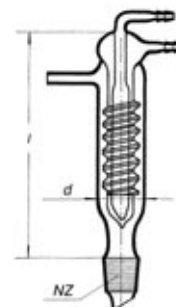

632 442 525 ***



632 415 623 ***



632 411 010 ***

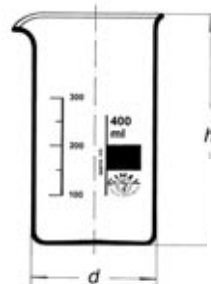

632 411 012 ***



632 411 008 ***

1.1. Laboratórne sklo



632 417 011 ***

632 417 011 *** Kadička nízka s uchom a výlevkou				Kat.č. 154
***	Objem (ml)	d (mm)	h (mm)	Balenie (ks)
250	250	70	95	6
400	400	80	110	6
600	600	90	125	6
940	1000	105	145	2

632 411 006 *** Kadička podľa Philipsa nízky tvar				Kat.č. 161	
***	Objem (ml)	d (mm)	d ₁ (mm)	h (mm)	Balenie (ks)
150	150	57	40	91	10
250	250	68	48	110	10
500	500	88	61	145	10
940	1000	112	70,5	184	10

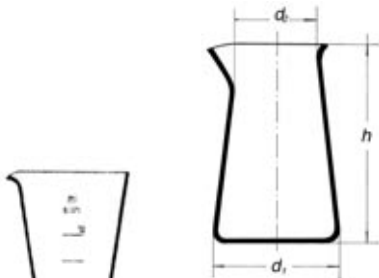

632 411 006 ***

632 534 104 *** Kahan liehový s klobúčikom				Kat.č. 2162
***	Objem (ml)			Balenie (ks)
050	50			1
100	100			10
200	200			1



632 514 061 ***

632 514 061 *** Kalíšok reagenčný (šampuska)				Kat.č. 3103
***	Objem (ml)			Balenie (ks)
100	100			1
200	200			1
250	250			1
500	500			1

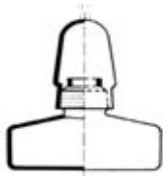

632 534 104 ***

Kapiláre lekárske

Vyrábajú sa v prevedení s protizrážanlivou úpravou, alebo bez úpravy. Druhy protizrážan. úpravy (PU) sú heparin sodný (najpoužívanejší typ), heparin amonný, heparin litný a chelaton (len u typu 95/195). Označenie kapilár je spracované v tabuľke a znamená dĺžku v mm / objem je v ml.

Ku kapilárom s PU č.1. - 5. dodávame miešacie drôtky, možno však objednať zvlášť.

Typ PU je nutné uviesť v objednávke.

- Typy:
- | | |
|--|--------------------------------|
| 1. až 5. na stanovenie acidobazickej rovnováhy | 8. - 9. hematokrytové kapiláre |
| 6. pre odbery na glykémie | 10. pre glukometre |
| 7. k vyšetreniu krvného obrazu | |

Minimálny odber je podľa tabuľky jedna ampula, druhy 1. - 7. sú balené po 10 ampulách v polystyrenovom obale.

632 *** *** ***								
***	***	***	Typ	Dĺžka (mm)	Vnútrotný Ø(mm)	Objem (ml)	ks (v ampuli)	
263	160	122	100/80 Bez PU	100	1,00	80	100	
262	161	122	1 100/80 s PU a drátky	100	1,00	80	100	
263	210	162	125/100 Bez PU	125	1,00	100	100	
262	211	162	2 125/100 s PU a drátky	125	1,00	100	100	
263	210	163	125/140 Bez PU	125	1,20	140	75	
262	211	163	3 125/140 s PU a drátky	125	1,20	140	75	
263	140	162	90/100 Bez PU	90	1,20	100	75	
262	141	162	4 90/100 s PU a drátky	90	1,20	100	75	
263	210	362	125/200 Bez PU	125	1,43	200	50	
262	211	362	5 125/200 s PU a drátky	125	1,43	200	50	
263	060	095	6 60/95 Bez PU	60	1,43	95	100	
263	090	195	95/195 Bez PU	95	1,63	195	25	
262	091	195	7 95/195 s PU	95	1,63	195	25	
263	110	081	75/60 Bez PU	75	1,00	60	200	
262	111	081	8 75/60 s PU	75	1,00	60	200	
263	060	041	50/40 Bez PU	50	1,00	40	200	
262	061	041	9 50/40 s PU	50	1,00	40	200	
263	010	002	10 21,5/20 Bez PU	21,5	1,085	20	500	
921 060 010 drôtky miešacie - balenie podľa				počtu ks kapilár v ampuli				

Pomôcky pre odber krvi:

Uzáver pre typ 125/140 a 90/100 (zelený) - balenie á 1500 ks

Uzáver pre typ 125/200 (čierny) - balenie á 1000 ks

Magnety

Súprava č. I

Súprava č. II

Súprava č. III.

Súprava č. IV.



634 709 ** ****Kapiláty s ryskou**

Pre jednorázové odmerávanie mikroobjemov

*** **	Počet trysiek	Objem (ul)	Balenie (ks)
600 105	5	1+2+3+4+5	250
600 110	1	10	250
600 120	1	20	250
600 125	1	25	250
600 140	1	40	250
600 144	1	44,7	250
600 150	1	50	250
600 199	1	100	250
600 122	1	200	100
600 210	2	5+10	250
600 240	2	20+40	250
600 299	2	50+100	250
600 222	2	100+200	100
602 144	1	44,7 Na-hep	250



634 709 600 ***

632 261 * ******Kapiláry SIMAX**

*** **	d ₁ (mm)	d ₂ (mm)	ks/g	ks/kartón	kg/kartón	kg/paleta
050 526	5,0±0,25	0,5±0,1	65	256	16,6	464,8
051 026	5,0±0,25	1,0±0,1	63	256	16,1	450,8
051 526	5,0±0,25	1,5±0,1	60	256	15,4	431,2
061 026	6,0±0,25	1,0±0,1	92	170	15,6	436,8
061 526	6,0±0,25	1,5±0,1	89	170	15,1	422,8
062 026	6,0±0,25	2,0±0,1	84	170	14,3	400,4
062 526	6,0±0,25	2,5±0,1	78	170	13,3	372,4
071 526	7,0±0,25	1,5±0,1	123	122	15,0	420,0
072 026	7,0±0,25	2,0±0,1	118	122	14,4	403,2
072 526	7,0±0,25	2,5±0,1	112	122	13,7	383,6
081 026	8,0±0,25	1,0±0,1	166	100	16,6	464,8
081 526	8,0±0,25	1,5±0,1	162	100	16,2	453,6
082 026	8,0±0,25	2,0±0,1	158	100	15,8	442,4
082 526	8,0±0,25	2,5±0,1	152	100	15,2	425,6
083 026	8,0±0,25	3,0±0,1	144	100	14,4	403,2
083 526	8,0±0,25	3,5±0,1	136	100	13,6	380,8
091 526	9,0±0,25	1,5±0,1	207	81	16,8	470,4
092 026	9,0±0,25	2,0±0,1	202	81	16,4	459,2
092 526	9,0±0,25	2,5±0,1	196	81	15,9	445,2
093 026	9,0±0,25	3,0±0,1	189	81	15,3	428,4
093 526	9,0±0,25	3,5±0,1	181	81	14,7	411,6
101 526	10,0±0,3	1,5±0,1	257	64	16,4	459,2
102 026	10,0±0,3	2,0±0,1	252	64	16,1	450,8
102 526	10,0±0,3	2,5±0,1	246	64	15,7	439,6
103 026	10,0±0,3	3,0±0,1	239	64	15,3	428,4
103 526	10,0±0,3	3,5±0,1	231	64	14,8	414,4

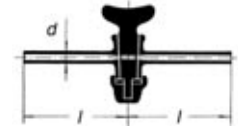

632 441 340 ***

632 441 340 *****Kohút priamy jednocestný s plným jadrom so skleneným kladivkom**

Kat.č. 7143

***	Označenie	Vŕtanie (mm)	l (mm)	d (mm)	Balenie (ks)
020	2	2,5	100	9	1
040	4	4,0	110	10	1
060	6	6,0	120	13	1
080	6	8,0	120	15	1

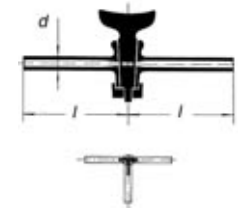

632 441 349 ***

632 441 349 *****Kohút trojcestný s vŕtaním tvaru T so skleneným kladivkom**

Kat.č. 7150

***	Označenie	Vŕtanie (mm)	l (mm)	d (mm)	Balenie (ks)
020	2	2,5	100	9	1
040	4	4,0	110	10	1
060	6	6,0	120	13	1

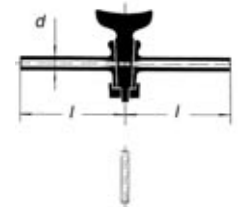

632 441 345 ***

632 441 345 *****Kohút trojcestný s vŕtaním tvaru L so skleneným kladivkom**

Kat.č. 7151

***	Označenie	Vŕtanie (mm)	l (mm)	d (mm)	Balenie (ks)
020	2	2,5	100	9	1
040	4	4,0	110	10	1
060	6	6,0	120	13	1

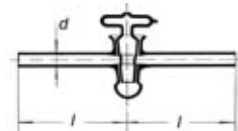

632 441 313 ***

632 441 313 *****Kohút vákuový priamy jednocestný**

Kat.č. 7160

***	Vŕtanie (mm)	l (mm)	d (mm)	Balenie (ks)
060	6	100	10	1
080	8	100	12	1
100	10	150	15	1

1.1. Laboratórne sklo

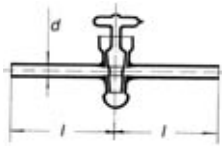

632 441 314 ***

632 441 314 *** Kohút vákuový priamy jednocestný s ortuťovým uzáverom Kat.č. 7161

***	Vŕtanie (mm)	l (mm)	d (mm)	Balenie (ks)
060	6	100	10	1
080	8	100	12	1
100	10	150	15	1

Na základe požiadavky dodáme aj ďalšie typy kohútov, ventilov jednocestných a dvojcestných priamych aj uhlových.

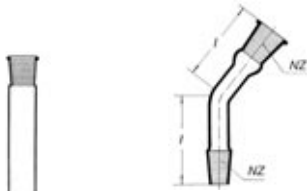

632 441 515 ***

632 441 515 *** Koleno s NZ v uhle 135° Kat.č. 8137 J/P

***	l (mm)	NZ	Balenie (ks)
050	63	14/23	1
080	77	29/32	1

Dodávame širší sortiment spojovacích dielov (kolen) v uhle 75°, 90°, 135°, v prevedení J/J lebo J/P.

632 441 402 ***

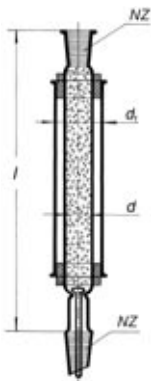

632 441 404 ***

632 441 402 *** Kolóna destilačná podľa Hempla s vložkou pre zadržanie náplne Kat.č. 8320

***	Výška plnenia	NZ	Balenie (ks)
302	300	14/23	1
502	500	14/23	1
505	500	29/32	1
755	750	29/32	1
995	1000	29/32	1

632 441 404 *** Kolóna destilačná podľa Hempla s izolačným plášťom a náplňou Raschigových krúžkov Kat.č. 8321

***	d (mm)	d1 (mm)	Výška plnenia	NZ	Balenie (ks)
505	34	46	500	29/32	1
755	34	40	750	29/32	1
995	34	46	1000	29/32	1

632 442 708 050



634 990 610 ***

632 442 708 *** Kolorimeter podľa Nesslerera Kat.č. 7210-7212

***	Kat. č.	Typ	Balenie (ks)
050	7210	1 značka 50 ml	1
100	7211	2 značky 50 - 100 ml	1
150	7212	3 značky 50 - 100 - 150 ml	1

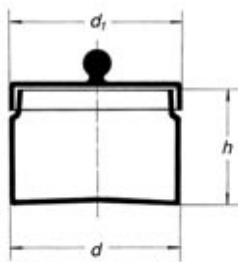

633 516 *** ***

634 *** ***** Komôrka počítacia s pacičkami, dvojité delenie síta

*** ***	Typ	Balenie (ks)
980 000 001	Cyrus I	1
990 640 211	Bürker CE	1
990 640 411	Fuchs-Rosenthal CE	1
990 610 511	Nageotte	1
990 640 711	Thoma CE	1
990 640 811	Thoma-neu CE	1
990 640 011	Neubauer-improved CE	1

Dodávame aj prevedenie bez pacičiek

633 516 *** *** Krabica na vatu s previslým vekom a guľičkovým hmatníkom Kat.č. 2205 SD

*** ***	d (mm)	h (mm)	Balenie (ks)
000 808	80	80	1
001 010	100	100	1
001 212	120	120	1
001 515	150	150	1
002 015	200	150	1
002 020	200	200	1

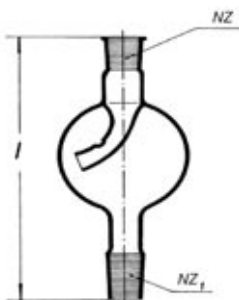

632 414 *** ***

632 441 536 *** Lapač kvapiek Kat.č. 8153

***	l (mm)	NZ1	NZ2	Balenie (ks)
050	130	14/23	14/23	1
080	170	29/32	29/32	1

632 *** *** *** Lievik s krátkou stonkou, uhol 60°				Kat.č. 2350
***	***	***	***	Balenie (ks)
	d ₁ (mm)	d ₂ (mm)	l (mm)	
413 001 035	35	6	35	10
413 001 045	45	6	45	10
413 001 055	55	8	55	10
413 001 075	75	9	75	10
413 001 085	85	9	85	10
413 001 100	100	12	100	10
413 001 125	125	16	125	6
413 001 150	150	16	150	6
413 001 200	200	24	150	6
413 001 250	250	30	175	2
413 001 300	300	34	175	2

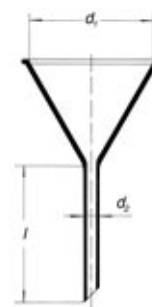

632 413 001 ***



632 413 004 ***

632 413 004 *** Lievik rebrovaný				Kat.č. 2360
***	d ₁ (mm)	d ₂ (mm)	l (mm)	Balenie (ks)
100	100	18	80	12
130	130	21	100	6
160	160	26	120	6
200	200	38	140	3
250	250	40	160	2

632 421 052 *** Lievik analytický pre rýchlu filtráciu				Kat.č. 2354
***	d ₁ (mm)	d ₂ (mm)	l (mm)	Balenie (ks)
055	55	8	150	10
075	75	8	150	10
100	100	8	150	10



632 421 052 ***

632 426 010 *** Lievik deliaci valcovitý, otvorený so skleneným kohútom				Kat.č. 2390
***	Objem (ml)	d (mm)	h (mm)	Balenie (ks)
050	50	9	150	4
100	100	9	150	4
250	250	9	150	2
500	500	10	150	2
940	1000	10	150	2

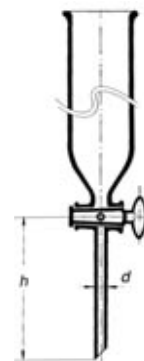

632 426 010 ***

632 426 351 *** Lievik deliaci guľovitý s NZ so sklenenou zátkou a skleneným kohútom					Kat.č. 2392
***	Objem (ml)	d (mm)	h (mm)	NZ	Balenie (ks)
050	50	9	150	19/26	4
100	100	9	150	19/26	4
250	250	9	200	29/32	2
500	500	10	200	29/32	2
940	1000	10	200	29/32	2
950	2000	13	200	29/32	1

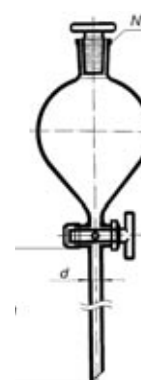

632 426 351 ***

632 426 353 *** Lievik deliaci podľa Gilsona s NZ s plastovou zátkou a teflonovým kohútom					Kat.č. 2393 T
***	Objem (ml)	d (mm)	h (mm)	NZ	Balenie (ks)
056	50	9	60	19/26	4
106	100	9	60	19/26	4
256	250	9	60	29/32	2
506	500	10	60	29/32	2
946	1000	10	60	29/32	2
956	2000	13	60	29/32	1

632 426 355 *** Lievik deliaci hruškovitý s NZ so sklenenou zátkou a skleneným kohútom					Kat.č. 2394
***	Objem (ml)	d (mm)	h (mm)	NZ	Balenie (ks)
050	50	9	70	19/26	4
100	100	9	70	19/26	4
250	250	9	70	29/32	2
500	500	10	70	29/32	2
940	1000	10	70	29/32	2
950	2000	13	70	29/32	2



632 426 355 ***

632 426 355 *** Lievik deliaci hruškovitý podľa Sguibba s NZ s plastovou zátkou a teflonovým kohútom					Kat.č. 2394 T
***	Objem (ml)	d (mm)	h (mm)	NZ	Balenie (ks)
056	50	9	70	19/26	4
106	100	9	70	19/26	4
256	250	9	70	29/32	2
506	500	10	70	29/32	2
946	1000	10	70	29/32	2
956	2000	13	70	29/32	2

1.1. Laboratórne sklo

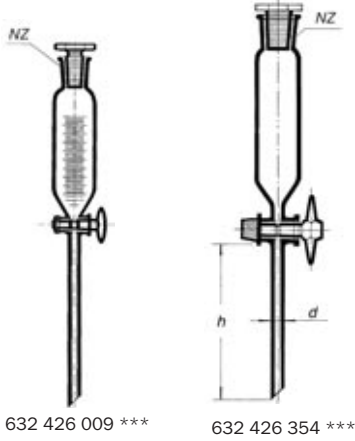

632 426 009 ***

632 426 354 ***



632 426 356 ***



632 413 301 ***

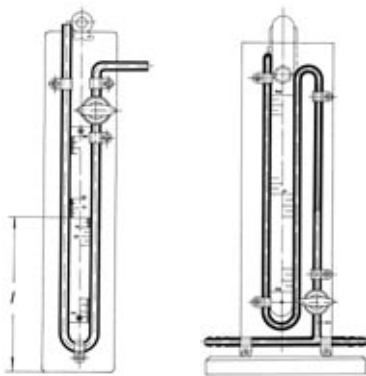

632 443 002 ***

632 443 003 ***



632 443 008 ***



634 061 000 ***

632 426 354 *** Lievik deliaci valcovitý s NZ Kat.č. 2397

so sklenenou zátkou, skleneným kohútom, bez stupnice

***	Objem (ml)	d (mm)	h (mm)	NZ	Balenie (ks)
050	50	9	150	19/26	4
100	100	9	150	19/26	4
250	250	9	150	29/32	2
500	500	10	150	29/32	2
940	1000	10	150	29/32	2
950	2000	13	150	29/32	1

632 426 009 *** Lievik deliaci valcovitý s NZ Kat.č. 2398

so sklenenou zátkou, skleneným kohútom, a stupnicou

***	Objem (ml)	d (mm)	h (mm)	NZ (mm)	Balenie (ks)
050	50	9	150	19/26	4
100	100	9	150	19/26	4
250	250	9	150	29/32	2
500	500	10	150	29/32	2
940	1000	10	150	29/32	2
950	2000	13	150	29/32	1

632 426 356 *** Lievik deliaci valcovitý príkvpávací s NZ Kat.č. 2399

so sklenenou zátkou a skleneným kohútom, bez stupnice

***	Objem (ml)	h (mm)	NZ (mm)	NZ ₁ (mm)	Balenie (ks)
050	50	50	19/26	14/24	1
100	100	50	19/26	14/24	1
250	250	65	29/32	29/32	2
500	500	65	29/32	29/32	1
940	1000	65	29/32	29/32	2
950	2000	65	29/32	29/32	1

632 413 301 *** Lodička na váženie Kat.č. 2606

***	Dĺžka (mm)	Sírka (mm)	Výška (mm)	Balenie (ks)
075	75	30	14	1
090	90	32	15	1
100	100	36	16	1
125	125	45	20	1

632 443 001 *** Manometer so stupnicou, bez kohúta na plechovej doske Kat.č. 7235

***	Objem (ml)	l (mm)	Balenie (ks)
150	150 - 0 - 150	255	1
250	250 - 0 - 250	455	1
500	500 - 0 - 500	955	1

Ako náhradný diel dodávame sklenenú časť manometra.

632 443 002 *** Manometer so stupnicou a kohútom na plechovej doske Kat.č. 7236

***	Objem (ml)	l (mm)	Balenie (ks)
100	100 - 0 - 100	155	1
150	150 - 0 - 150	255	1
250	250 - 0 - 250	455	1
500	500 - 0 - 500	955	1

Ako náhradný diel dodávame sklenenú časť manometra.

632 443 003 *** Manometer podľa Anschütza s posuvnou stupnicou Kat.č. 7238

***	Objem (ml)	popis	Balenie (ks)
100	100 - 0 - 100	bez ortuťovej náplne	1
101	100 - 0 - 100	s ortuťovou náplňou	1

Ako náhradný diel dodávame sklenenú časť manometra.

632 443 008 *** Manometer podľa Krella komplet na plechovej doske Kat.č. 7246

***	Objem (ml)	Balenie (ks)
035	0 - 35	2
060	0 - 60	2

Ako náhradný diel dodávame sklenenú časť manometra.

634 061 000 *** Miešadlo sklenené k magnetickej miešačke

***	d (mm)	l (mm)	Balenie (ks)
420	4	20	1
425	4	25	1
530	5	30	1
540	5	40	1
550	5	50	1
560	5	60	1

632 411 624 * Miska kryštalizačná bez výlevky, prevedenie DIN Kat.č. 174**

***	Objem (ml)	d (mm)	h (mm)	Balenie (ks)
040	20	40	25	1
050	40	50	30	1
060	60	60	35	10
070	100	70	40	10
080	150	80	45	10
095	300	95	55	10
115	500	115	65	10
140	900	140	75	10
190	2000	190	90	4
230	3500	230	100	3

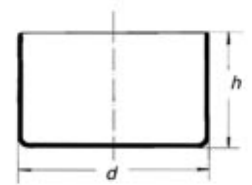

632 411 624 ***

632 411 625 * Miska kryštalizačná s výlevkou, prevedenie DIN Kat.č. 175**

***	Objem (ml)	d (mm)	h (mm)	Balenie (ks)
040	20	40	25	1
050	40	50	30	1
060	60	60	35	10
070	100	70	40	10
080	150	80	45	10
095	300	95	55	10
115	500	115	65	10
140	900	140	75	10
190	2000	190	90	4
230	3500	230	100	3

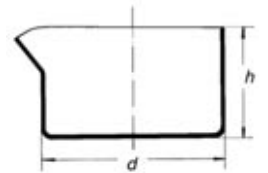

632 411 625 ***

632 411 607 * Miska odparovacia bez výlevky s gufatým dnom Kat.č. 176**

***	Objem (ml)	d (mm)	h (mm)	Balenie (ks)
050	25	51	22	10
060	50	64	29	10
080	100	85	39	10
100	250	105	49	10
130	500	131	62	10
160	1000	166	80	8
200	2000	206	100	4
230	3000	235	115	3



632 411 607 ***

632 411 604 * Miska odparovacia s výlevkou s gufatým dnom Kat.č. 177**

***	Objem (ml)	d (mm)	h (mm)	Balenie (ks)
050	25	51	22	10
060	50	64	29	10
080	100	85	39	10
100	250	105	49	10
130	500	131	62	10
160	1000	166	80	8
200	2000	206	100	4
230	3000	235	115	3



632 411 604 ***

632 411 628 * Miska odparovacia bez výlevky ploché dno Kat.č. 178**

***	Objem (ml)	d ₁ (mm)	h (mm)	Balenie (ks)
050	15	50	25	11
060	45	60	30	10
070	60	70	35	10
080	90	80	45	10
095	170	95	55	10
115	320	115	65	10
140	600	140	80	10
230	2500	230	130	1



632 411 628 ***

632 411 629 * Miska odparovacia s výlevkou s plochým dnom, prevedenie DIN Kat.č. 179**

***	Objem (ml)	d ₁ (mm)	d ₂ (mm)	h (mm)	Balenie (ks)
040	10	40	20	18	1
050	15	50	25	25	10
060	45	60	30	30	10
070	60	70	32	35	10
080	90	80	35	45	10
095	170	95	40	55	10
115	320	115	50	65	10
140	600	140	60	80	10
190	1500	190	80	100	4
230	2500	230	100	130	3

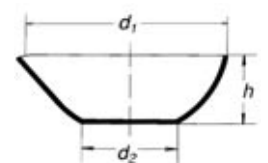

632 411 629 ***

1.1. Laboratórne sklo

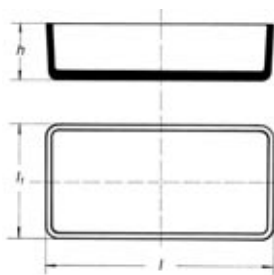

632 531 121 ***

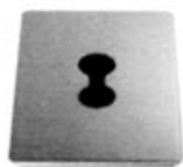

397 531 122 ***



632 538 160 ***
632 538 150 ***

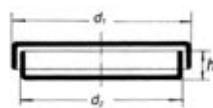

632 492 *** ***



632 413 103 ***

632 531 121 *** Miska dezinfekčná bez viečka **Kat.č. 3250**

***	l (mm)	l ₁ (mm)	h (mm)	Balenie (ks)
202	200	100	100	6
203	200	100	50	6
204	250	165	60	3
205	250	165	120	3

632 531 122 *** Miska dezinfekčná s kovovým nerezovým viečkom **Kat.č. 3251**

***	l (mm)	l ₁ (mm)	h (mm)	Balenie (ks)
202	200	100	100	1
203	200	100	50	1
204	250	165	60	1
205	250	165	120	1

397 531 122 *** Viečko nerezové s hmatníkom k dezinfekčnej miske **Kat.č. 3252/V**

***	Typ	l (mm)	l ₁ (mm)	Balenie (ks)
201	malé	200	100	1
206	veľké	250	165	1

632 538 160 *** Miska trecia drsná s tľčíkom **Kat.č. 2230**

***	d ₁ (mm)	d ₂ (mm)	h (mm)	Balenie (ks)
080	80	50	60	12
100	100	60	75	1
120	120	70	90	1
150	150	85	110	1
200	200	120	135	1

632 538 150 *** Miska trecia hladká s tľčíkom **Kat.č. 2231**

***	d ₁ (mm)	d ₂ (mm)	h (mm)	Balenie (ks)
080	80	50	60	12
100	100	60	75	1
120	120	70	90	1
150	150	85	110	1
200	200	120	135	1

632 *** *** *** Miska Petriho **Kat.č. 2290**

*** *** ***	Sila steny (mm)	d (mm)	h (mm)	Balenie (ks)
492 002 040	1,2	40	12	288
492 002 050	1,2	50	12	288
492 002 060	1,2	60	12	144
492 003 060	1,2	60	15	144
492 003 070	1,35	70	15	72
492 003 080	1,35	80	15	72
492 003 090	1,35	90	15	72
492 001 100	1,35	100	10	72
492 003 100	1,5	100	15	72
492 004 100	1,5	100	20	72
492 004 120	1,5	120	20	72
492 005 150	1,5	150	25	72
492 006 180	1,9	180	30	10
492 006 200	1,9	200	30	10
492 008 200	1,9	200	50	10
491 001 071	2,0	250	50	Simax 1
491 001 076	2,0	300	55	Simax 1

632 413 103 *** Násypka s krátkym rovným koncom **Kat.č. 2356**

***	d ₁ (mm)	d ₂ (mm)	h (mm)	Balenie (ks)
050	50	20	50	10
060	60	20	60	10
080	80	25	75	10
100	100	25	95	10
120	120	30	110	10
160	160	35	135	6
200	200	38	180	6

632 413 102 *** Násypka s krátkym šikmým koncom				Kat.č. 2357
***	d ₁ (mm)	d ₂ (mm)	h (mm)	Balenie (ks)
060	60	10	30	1
080	80	12	32	1
100	100	15	35	1
150	150	32	52	1

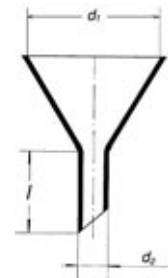

632 413 102 ***

632 441 667 *** Nástavec destilačný s NZ a špirálovým chladičom				Kat.č. 8176
***	l (mm)	NZ (mm)	Balenie (ks)	
060	300	19/26	1	
070	300	24/29	1	
080	300	29/32	1	

632 441 664 *** Nástavec destilačný s chladičom a NZ 14/23 pre teplomer				Kat.č. 8174
***	l (mm)	NZ (mm)	NZ ₁ (mm)	Balenie (ks)
403	400	19/26	14/23	1
603	600	19/26	14/23	1
405	400	29/32	14/23	1
605	600	29/32	14/23	1



632 441 662 ***

632 441 662 *** Nástavec destilačný podľa Claisena s NZ				Kat.č. 8173
***	L (mm)	NZ ₁	NZ ₂	Balenie (ks)
050	90	14/23	14/23	1
080	100	14/23	29/32	1

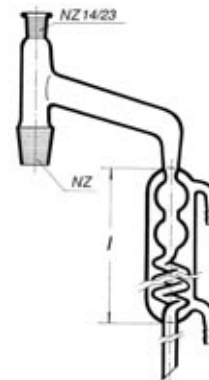

632 441 667 ***

632 515 102 *** Odmerka liekov				Kat.č. 3531
***	Ø (mm)	h (mm)	Balenie (ks)	
000	51	61	24	

632 421 203 *** Odvažovačka na žieraviny				Kat.č. 7446
***	Typ	Prevedenie	Balenie (ks)	
051	SV295	so skleneným kohútom	1	
052	SV503	s teflonovým ventilom s VT 0-2	1	



632 421 203 ***

632 421 *** *** odvažovačka - vážienka so zabrúseným viečkom						Kat.č. 2602
***	***	Prevedenie	d (mm)	h (mm)	Objem (ml)	Balenie (ks)
201	253	Nízka	25	30	10	50
201	353	Nízka	35	30	15	50
201	403	Nízka	40	30	20	50
202	503	Nízka	50	30	30	10
202	603	Nízka	60	30	40	10
202	803	Nízka	80	30	80	10
201	254	Vysoká	25	40	10	50
201	305	Vysoká	30	50	20	50
201	356	Vysoká	35	60	35	50
301	408	Vysoká	40	80	70	20

632 433 011 *** Pipeta nedelená, COLOR CODE, trieda presnosti A, s jednou rýskou, rovné prevedenie, farebné značenie				Kat.č. 1595/1ASR
***	Objem (ml)	Farebný kód	Balenie (ks)	
014	1	modrý	50	
016	2	oranžový	50	

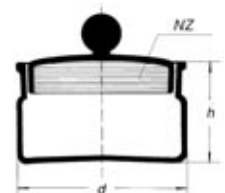

632 421 *** ***

632 433 111 *** Pipeta nedelená, COLOR CODE, ciachovaná, trieda presnosti A, s jednou rýskou, rozšírené prevedenie, farebné značenie				Kat.č. 1595/ASC
***	Objem (ml)	Farebný kód	Balenie (ks)	
901	1	modrý	1	
902	2	oranžový	1	
905	5	biely	1	
910	10	červený	1	
920	20	žltý	1	
925	25	modrý	1	
950	50	červený	1	
990	100	žltý	1	

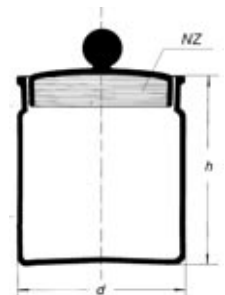

632 421 *** ***

632 433 011 ***

1.1. Laboratórne sklo



632 433 111 ***

632 433 111 *** Pipeta nedelená, COLOR CODE Kat.č. 1595/1AS

trieda presnosti A,
s jednou ryskou, rozšírené prevedenie, farebné značenie

***	Objem (ml)	Farebný kód	Balenie (ks)
014	1	modrý	50
016	2	oranžový	50
017	3	čierny	50
018	5	biely	25
019	10	červený	25
021	15	zelený	25
022	20	žltý	10
023	25	modrý	10
024	30	čierny	10
057	40	biely	1
025	50	červený	1
058	75	zelený	1
030	100	žltý	1
037	200	modrý	1



632 434 136 ***

632 434 136 *** Pipeta delená, Kat.č. 1605/AS

trieda presnosti A, úplný výtok

***	Objem (ml)	Delenie (ml)	Balenie (ks)
314	1	0,01	50
516	2	0,02	50
618	5	0,05	50
719	10	0,1	50
722	20	0,1	25
723	25	0,1	25
725	50	0,1	5
830	100	0,2	5



632 434 116 ***

632 434 136 *** Pipeta delená, ciachovaná Kat.č. 1605/ASC

trieda presnosti A, úplný výtok

***	Objem (ml)	Delenie (ml)	Balenie (ks)
901	1	0,01	1
902	2	0,02	1
905	5	0,05	1
910	10	0,1	1
925	25	0,1	1

632 434 116 *** Pipeta delená, COLOR CODE Kat.č. 1605/ASB

trieda presnosti A, úplný výtok, farebné značenie

***	Objem (ml)	Delenie (ml)	Farebný kód	Balenie (ks)
312	0,5	0,01	2 x žltý	50
314	1	0,01	žltý	50
516	2	0,02	čierny	50
618	5	0,05	červený	50
719	10	0,1	oranžový	50
722	20	0,1	2 x žltý	25
723	25	0,1	biely	25
725	50	0,1	2 x oranžový	5
830	100	0,2	červený	5

632 434 116 *** Pipeta delená, COLOR CODE, ciachovaná Kat.č. 1605/ASBC

trieda presnosti A, úplný výtok, farebné značenie

***	Objem (ml)	Delenie (ml)	Farebný kód	Balenie (ks)
901	1	0,01	žltý	1
902	2	0,02	čierny	1
905	5	0,05	červený	1
910	10	0,1	oranžový	1
925	25	0,1	biely	1



632 434 580 010

632 434 *** *** Pipeta delená mikrobiologická, Kat.č. 1605/M

rozšírený otvor

*** ***	Objem (ml)	Delenie (ml)	Balenie (ks)
050 314	1	0,01	50
050 516	2	0,02	50
050 618	5	0,05	50
050 719	10	0,1	50
050 723	25	0,1	25

632 434 580 *** Náustok delených pipiet 1605/ 1ml a 2ml, PE Kat.č. 4580

mikrobiologický, rozšírený otvor

***	Balenie (ks)
010	1

632 434 410 *** Pipeta s automatickým nastavením nulového bodu			Kat.č. 1607
***	Objem (ml)		Balenie (ks)
019	10		1
023	25		1
025	50		1
030	100		1
059	356,4		1

632 436 760 *** Pipeta automatická s uzavretým rezervoárom			Kat.č. 1612
***	Objem (ml)		Balenie (ks)
014	1		1
016	2		1
018	5		1
019	10		1

632 436 750 *** Pipeta automatická s delenou stupnicou			Kat.č. 1614
***	Objem (ml)	Delenie (ml)	Balenie (ks)
618	5	0,05	1
719	10	0,1	1

632 434 710 *** Mikropipeta Sahliho				Kat.č. 3405
***	Objem (µl)	Povolená odchylka (µl)	Dĺžka (mm) ±15	Balenie (ks)
022	20	±0,4	125	50

632 434 720 *** Mikropipeta Bürkera na riedenie krvi				Kat.č. 3406
***	Objem (µl)	Povolená odchylka (µl)	Dĺžka (mm) ±15	Balenie (ks)
023	25	±0,5	125	50

632 434 434 *** Pipeta sedimentačná, ciachovaná				Kat.č. 3420
***	Stupnica (mm)	Povolená odchylka (ml)	Dĺžka (mm) ±2	Balenie (ks)
011	0 - 200	± 0,4	300	1

632 993 233 *** Pipeta podľa Pasteura, vytiahnutá do špičky			
***	Dĺžka špičky (mm)	Dĺžka (mm)	Balenie (ks)
049	40	150	1000
050	100	230	1000

632 434 980 *** Náustok pre mikropipety		Kat.č. 4980
***		Balenie (ks)
020		50

Ostatné druhy mikropipiet Vám radi ponúkame na vyžiadanie.

632 446 003 *** Pipeta sklopná - špaček				Kat.č. 7365
kompletná (vrátane Erlenmeyerovy banky)				
***	Objem špačka (ml)	Objem banky (ml)	NZ	Balenie (ks)
001	1	250	29/32	24
002	2	250	29/32	24
005	5	250	29/32	24
010	10	500	29/32	15
020	20	500	29/32	15
025	25	500	29/32	15
030	30	1000	29/32	10
050	50	1000	29/32	10

632 446 003 *** Pipeta sklopná - špaček				Kat.č. 7365/N
len nástavec				
***	Objem špačka (ml)	NZ	Balenie (ks)	
101	1	29/32	1	
102	2	29/32	1	
105	5	29/32	1	
110	10	29/32	1	
120	20	29/32	1	
130	30	29/32	1	
150	50	29/32	1	

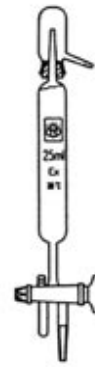

632 434 410 ***

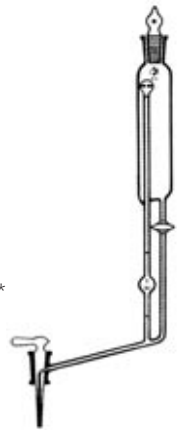

632 436 760 ***

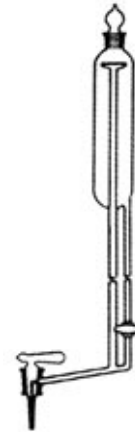

632 436 750 ***



632 434 980 020



632 434 720 023



632 434 434 011

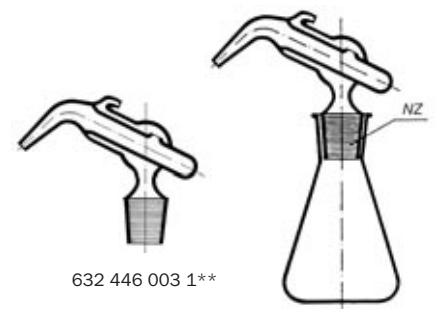

632 446 003 1**

632 446 003 0**

1.1. Laboratórne sklo

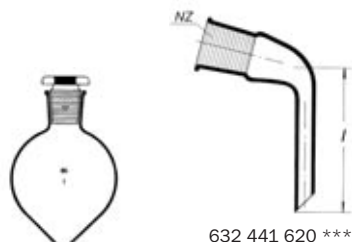

632 441 620 ***



632 446 004 001



632 441 619 ***

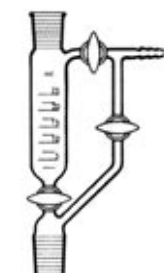

632 441 606 ***

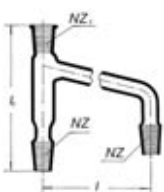

632 441 533 ***



632 441 521 ***



632 431 722 ***



632 431 710 ***

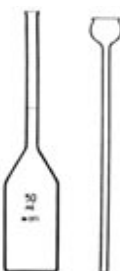

632 431 900 900

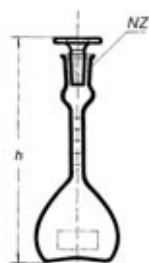

632 431 831 023



632 431 762 023

632 446 *** *** Pipeta permanentná Kat.č. 7366, 7367

		na kyselinu a amylalkohol		
***	***	Dávkovací objem (ml)	Nádrž (ml)	Balenie (ks)
004	001	1	500	1
004	010	10	1000	1

632 441 620 *** Predloha destilačná s NZ (alonž) Kat.č. 8179

***	l (mm)	NZ	Balenie (ks)
050	60	14/23	1
060	100	19/26	1
080	120	29/32	1

632 441 606 *** Predloha destilačná Kat.č. 8182

		podľa Anschütz-Thiele	
***	Objem (ml)	NZ	Balenie (ks)
050	25	14/23	1
080	50	29/32	1

632 441 619 *** Predloha na odber refluxu Kat.č. 8155

		podľa Junga s NZ 14/23 pre teplomer		
***	h (mm)	NZ	NZ ₁	Balenie (ks)
050	130	14/23	14/23	1
060	140	19/26	14/23	1
070	150	24/29	14/23	1
080	160	29/32	14/23	1

632 441 521 *** Priestupník s príkľapkávajúcim lievikom Kat.č. 8146

***	Objem (ml)	l (mm)	NZ	Balenie (ks)
050	50	200	14/23	1
080	80	200	29/32	1

632 441 533 *** Priestupník s NZ 14/23 pre teplomer Kat.č. 8148

***	l (mm)	l ₁ (mm)	NZ	NZ ₁	Balenie (ks)
050	300	113	14/23	14/23	1
080	300	132	29/32	14/23	1

632 431 710 *** Pyknometer podľa Kovářa Kat.č. 1620

***	Objem (ml)	Balenie (ks)
025	50	1
030	100	1

632 431 722 *** Pyknometer podľa Gay - Lussaca Kat.č. 1621

***	Objem (ml)	Presnosť (ml) ±	d (mm)	h (mm)	Balenie (ks)
019	10	1	27	55	10
023	25	2	40	75	10
025	50	3	50	85	10
030	100	5	57	100	10

632 431 *** *** Pyknometer podľa Reischauera Kat.č. 1622

***	Objem (ml)	Typ	Balenie (ks)
730 025	50	ryskou + lievik	1
831 023	25	trubicový so stupnicou	10
831 025	50	trubicový so stupnicou	10
830 023	25	kapilárny, so stupnicou	1
830 025	50	kapilárny, so stupnicou	1
832 023	25	trubicový s ryskou	1
832 025	50	trubicový s ryskou	1

632 431 762 *** Pyknometer podľa Hubbarda Kat.č. 1623

***	Objem (ml)	Balenie (ks)
023	25	1

632 431 900 *** Pyknometer pivovarnický Kat.č. 1625

***	Objem (ml)	Typ	Balenie (ks)
900	50	bez zátky, s plniacim lievikom	1
910	50	bez zátky, bez lievika - veľmi úzke hrdlo	1

632 431 901 *** Pyknometer cestný s NZ 45/40						Kat.č. 1627
nástavcom a lievikom						
***	Objem (ml)	d ₃ (mm)	d ₂ (mm)	d ₁ (mm)	h (mm)	Balenie (ks)
720	500	40	10	105	355	1
740	1000	40	10	131	385	1

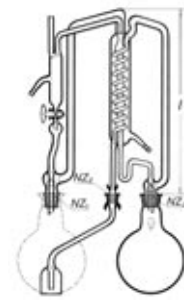

632 441 612 950



632 431 901 ***

632 441 610 *** Prístroj destilačný podľa Femela, s NZ				Kat.č. 8360
***	Objem (ml)	NZ		Balenie (ks)
940	1000	29/32		1
950	2000	29/32		1

632 441 611 *** Prístroj destilačný s NZ na predestilovanie vody,				Kat.č. 8361
***	Objem (ml)	NZ		Balenie (ks)
940	1000	29/32		1
950	2000	29/32		1

632 441 612 *** Prístroj destilačný				Kat.č. 8364
na nepretržitú destiláciu a redestiláciu vody				
***	Objem (ml)	NZ		Balenie (ks)
950	2000	29/32		1

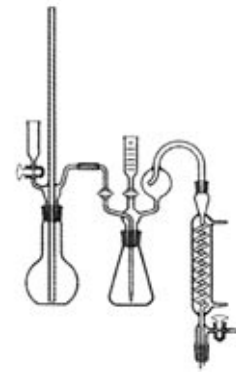

632 445 102 500



632 441 611 ***

632 446 205 *** Prístroj destilačný spojený, s NZ 29/32				Kat.č. 6205
GL 18 (len nástavec)				
***	Prevedenie	l (mm)	Označenie	Balenie (ks)
003	malý	300	SV 318	1
005	veľký	500	SV 319	1

Ku kompletnej zostave je treba doobjednať banku s plochým dnom kat.č. 8003/2000 ml a teplomer obalový liehový kat.č. 111055.

632 441 610 *** Prístroj destilačný na ovocie,				
vrátane banky				
***	Prevedenie	Objem banky (ml)		Balenie (ks)
310	bez stojana	6000		1
311	so stojanom	6000		1

632 441 617 *** Prístroj destilačný Markuson				Kat.č. 8746
***	Objem (ml)	NZ		Balenie (ks)
940	1000	29/32		1
950	2000	29/32		1

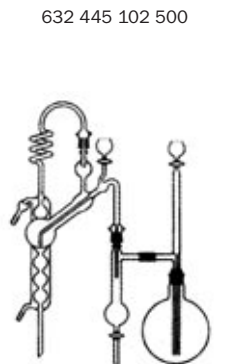

632 445 208 100

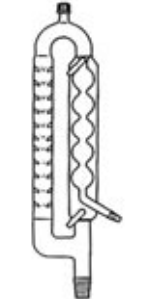

632 446 205 005

632 445 102 *** Prístroj na stanovenie alkoholu podľa Šťastného				Kat.č. 8580
***				Balenie (ks)
500				1

632 447 707 *** Prístroj na stanovenie vody xylénom				Kat.č. 8564
podľa Dean Starcka				
***	Objem (ml)	Delenie	NZ	Balenie (ks)
002	2,5	1:20	29/32	1
005	5	1:10	29/32	1
010	10	1:10	29/32	1
020	20	1:05	29/32	1

Banka a chladič sú pre všetky predlohy rovnaké, nástavce je možno dodať zvlášť.

632 445 *** *** Prístroj Orsat na absorpčnú analýzu plynov				
***	Objem(ml)	Prevedenie	Kat. č.	Balenie (ks)
522 050	50	3-miestny kompletný	7525/3m/50ml	1
522 101	100	3-miestny kompletný	7525/3m/typ80/100	1
524 050	50	6-miestny kompletný	7526/6m/50ml	1
524 110	100	6-miestny kompletný	7526/6m/typ80/100	1

632 445 *** *** Prístroj Parnas Wagner zabrúsený,				
na absorpčnú analýzu plynov				
***	Označenie	Prevedenie	Kat. č.	Balenie (ks)
228 100	mikrodest.	so stojanom	8460	1
208 100	mikrodest.	bez stojana	8460	1
209 500	makrodest.	so stojanom	8461	1
209 530	makrodest.	bez stojana	8461	1

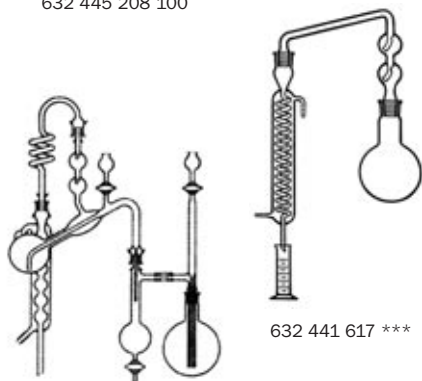

632 445 209 530

632 441 617 ***

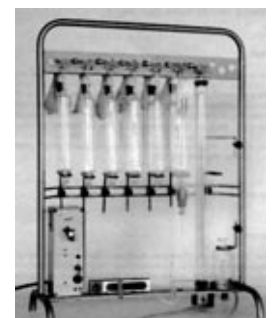

632 445 209 530

1.1. Laboratórne sklo



632 447 702 ***



632 442 110 940



632 447 803 000



632 442 103 ***



632 442 104 ***

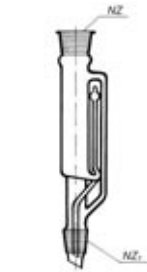

632 442 101 ***



632 442 108 090

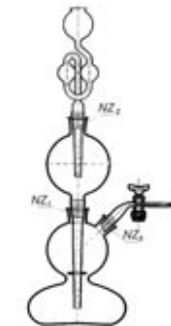

632 415 106 ***



632 447 103 600

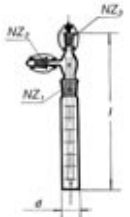

632 441 106 030

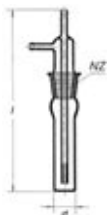

632 441 106 050

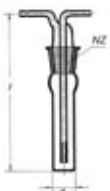

632 441 106 100

632 447 *** *** Prístroj podľa Winklera				Kat.č. 2772
na určenie vody – kompletný s pipetkou				
	Objem (ml)	Kat. č.	NZ	Balenie (ks)
632 447 702 150	100-150	2772	14/23	1
632 447 702 300	250-300	2772	19/26	1
632 447 702 152	Pipetka 5 ml	2772b		1

Samostatné „kyslíkovky“ vid. fľaše.

632 442 110 *** Prístroj na stanovenie sílic v rastlinných drogách				Kat.č. 8504
bez banky				
	Popis			Balenie (ks)
951	Podľa liekopisu			1
940				1

632 447 803 *** Prístroj - vápnomer podľa Janka				Kat.č. 7771
so stojanom				
	Prevedenie			Balenie (ks)
000	So stupnicou do 5% Ca CO ₃			1

632 442 103 *** Prístroj extrakčný podľa Soxhletha				Kat.č. 8730
s chladičom podľa Allihna				
	Objem (ml)	NZ	NZ ₁	Balenie(ks)
100	100	45/40	29/32	1
200	200	55/50	29/32	1
500	500	60/46	29/32	1
940	1000	71/51	29/32	1

632 442 104 *** Prístroj extrakčný podľa Soxhletha				Kat.č. 8730/F	
s chladičom podľa Allihna a fritovou vložkou S1					
	Objem (ml)	l/d (mm)	NZ	NZ ₁	Balenie (ks)
030	30	88/22	29/32	29/32	1
070	70	100/25	34/35	29/32	1
100	100	94/36	45/40	29/32	1
200	200	123/38	55/50	29/32	1
500	500	200/46	60/46	29/32	1
940	1000	300/62	71/51	29/32	1

632 442 101 *** Nástavec extrakčný podľa Soxhletha				Kat.č. 8293
k prístroju podľa Soxhletha				
	Objem (ml)	NZ	NZ ₁	Balenie (ks)
030	30	29/32	29/32	1
070	70	34/35	29/32	1
100	100	45/40	29/32	1
200	200	55/50	29/32	1
500	500	60/46	29/32	1
940	1000	71/51	29/32	1

632 442 108 *** Prístroj extrakčný podľa Twiselmanna,				Kat.č. 8308
kompletný, nové prevedenie kohúta				
	Objem (ml)	NZ	NZ ₁	Balenie (ks)
090	250	34/35	29/32	1

632 415 106 *** Prístroj Kippov				Kat.č. 2442	
s poglobovitým spodným dielom a zabrušeným príslušenstvom					
	Objem (ml)	NZ ₁	NZ ₂	NZ ₃	Balenie (ks)
500	500	29/32	29/32	29/32	1
940	1000	34/35	34/35	29/32	1
950	2000	34/35	34/35	29/32	1

632 441 106 *** Prístroj na absorpciu prašných látok zo vzduchu				Kat.č. 8757		
(Impinger)						
	Objem (ml)	d (mm)	l (mm)	Označenie	NZ	Balenie (ks)
030	30	22	225	A	19/26	1
050	50	26	270	B	29/32	1
100	100	26	290	C	29/32	1

632 447 103 *** Prístroj na stanovenie síry Ströhlein				Kat.č. 8521
	Objem (ml)	NZ		Balenie (ks)
600	600	45/40		1

632 447 601 ***	Prístroj na stanovenie uhlíka Ströhlein, bez skrinky	Kat.č. 7742
***		Balenie (ks)
000		1

Samostatné diely je nutné objednať zvlášť.

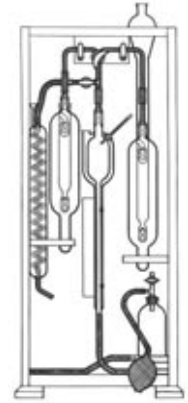

632 447 601 000

632 447 806 ***	Prístroj podľa Kleina na stanovenie CO₂	Kat.č. 7775
***		Balenie (ks)
050		1

632 449 888 ***	Prístroj na stanovenie destilačného rozmedzia	
***		Balenie (ks)
003		1

Teplomer, zábrus NZ 14/23 - treba objednať zvlášť

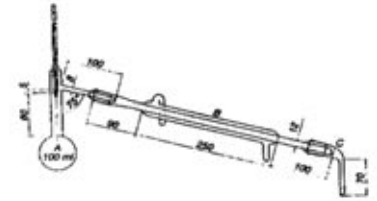

632 449 888 003

632 442 117 ***	Prístroj na stanovenie formaldehydu kompletný	Kat.č. 8458
***		Balenie (ks)
010		1

632 449 925 ***	Prístroj na stanovenie kyselín vo víne	Kat.č. 9296
***		Balenie (ks)
900		1

632 445 200 ***	Prístroj na stanovenie arzénu - pre limitnú skúšku A na arzén	
***	Objem (ml)	Balenie (ks)
100	100	1

632 445 250 ***	Prístroj na separáciu kyanovodíka vytesňovaním	Kat.č. 9297
***		Balenie (ks)
010		1

Prístroje destilačné na vodu

Dodávame sklenené aparatúry SIMAX určené na výrobu destilovanej vody, ktorej kvalita zodpovedá ČSN 68 4063. Podľa typu je výkon 4-90 litrov za hodinu.

Prevedenie topných telies: a) priame elektródové vyhrievanie (elektródy z nerez plechu alebo grafitových tvaroviek)
b) priame elektrické vyhrievanie
c) vyhrievací had (vyhrievanie parou)

Destilačné prístroje na vodu sú určené výhradne k destilácii vody tam, kde kapacitné nároky na destilovanú vodu zodpovedajú menovitým výkonom jednotlivých typov (predovšetkým vo farmácii, zdravotníctve, fotochemických a chemických prevádzkach). Prístroje sú určené prevažne k destilácii vôd bežných tvrdostí 7 až 15 °N, zložením zodpovedajúcich ČSN 830611 pre pitnú vodu (vstupná voda). Destilačný prístroj s predradeným zmäčkovacím filtrom je vhodný pre miesta, kde napájacia voda má celkovú tvrdosť v rozmedzí od 15 do 20 °N. Redestilačný prístroj poskytuje priemerne desať litrov destilovanej a tri litre redestilovanej vody za hodinu. Destilačné prístroje pracujú pri bežnom atmosférickom tlaku.

	Typ	Popis	Príkon (kW)	Chladiaca voda (l/h)	Výkon (l/h)
632 612 008 210	I-DPE 4-RZ	Závesné prevedenie	2,8	30-50	3,5-4
632 612 008 110	I-DPE 4-RS	Stolové prevedenie	2,8	30-50	3,5-4
632 612 009 007	I-DPE 10/4-7/	Delený, pre tvrdosť vody 4-7 °N	5,9-10,5	110-150	7,4-14,5
632 612 009 012	I-DPE 10/8-18/	Delený, pre tvrdosť vody 8-18 °N	5,9-10,5	110-150	7,4-14,5
632 612 009 017	I-DPE 10/19-25/	Delený, pre tvrdosť vody 19-25 °N	5,9-10,5	110-150	7,4-14,5
632 612 009 022	I-DPE 10 /graf.elektroda/*	Delený, grafitová elektróda	5,9-10,5	110-150	7,4-14,5
632 612 010 010	I-DPE 10-ZF*	Delený, so zmäčkovacím filtrom	5,9-10,5	110-150	7,4-14,5
632 612 011 301	I-DPE 30-Z**	Závesné prevedenie	19,9-26,6	300-400	28-35

*Pri objednaní destilačného prístroja je treba upresniť typ elektródy

** Len do vypredania zásob

Ku všetkým typom prístrojov dodávame tiež náhradné diely.

Dodávame i priemyslové aparatúrne prístroje a diely SIMAX.

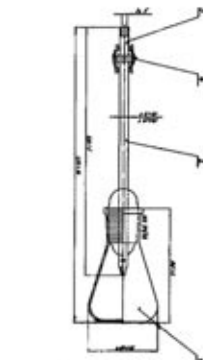

632 445 200 100

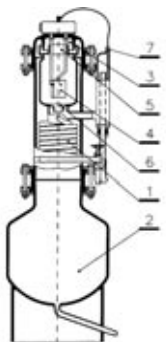

632 612 008 100

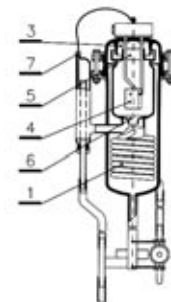

632 612 008 200

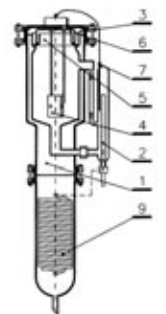

632 612 011 ***

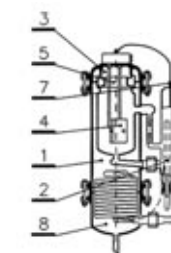

632 612 009 ***

1.1. Laboratórne sklo



632 523 001 000

632 523 001 ***	Rúrka pitná s plochým náustkom	Kat.č. 3493
***		Balenie (ks)
000		10



632 523 521 000

632 523 021 ***	Rúrka rektálna s postranným otvorom	Kat.č. 3494
***		Balenie (ks)
000		10



632 523 201 ***

632 523 201 ***	Rúrka spojovacia priama s olivkami			Kat.č. 7571
***	d (mm)	l (mm)	Prevedenie	Balenie (ks)
105	4	50	s olivkami	10
206	5	60	s olivkami	10
306	6	60	s olivkami	10
406	7	60	s olivkami	10
507	8	70	s olivkami	10
608	10	80	s olivkami	10
810	12	100	s olivkami	10



632 523 221 ***

632 523 221 ***	Rúrka spojovacia s olivkami, tvar L			Kat.č. 7574
***	d (mm)	l (mm)	Prevedenie	Balenie (ks)
104	4	40	s olivkami	10
306	6	60	s olivkami	10
506	8	60	s olivkami	10
606	10	60	s olivkami	10
806	12	60	s olivkami	10



632 523 231 ***

632 523 231 ***	Rúrka spojovacia s olivkami, tvar T			Kat.č. 7576
***	d (mm)	l (mm)	Prevedenie	Balenie (ks)
105	4	50	s olivkami	10
395	6	55	s olivkami	10
506	8	60	s olivkami	10
696	10	65	s olivkami	10
896	12	65	s olivkami	10

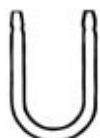

632 523 251 ***

632 523 251 ***	Rúrka spojovacia s olivkami, tvar U			Kat.č. 7580
***	d (mm)	l (mm)	Prevedenie	Balenie (ks)
105	4	50	s olivkami	10
305	6	50	s olivkami	10
506	8	60	s olivkami	10
606	10	60	s olivkami	10
806	12	60	s olivkami	10



632 523 241 ***

632 523 241 ***	Rúrka spojovacia s olivkami, tvar Y			Kat.č. 7578
***	d (mm)	l (mm)	Prevedenie	Balenie (ks)
103	4	30	s olivkami	10
393	6	35	s olivkami	10
504	8	40	s olivkami	10
694	10	45	s olivkami	10
894	12	45	s olivkami	10



632 523 60* ***

632 523 *** ***	Rozbočka hrebeňová s olivkami		Kat.č. 7581
*** ***	Počet vývodov	d (mm) vývodov	Balenie (ks)
601 000	3	7 - 8	1
602 000	4	7 - 8	1
603 000	6	7 - 8	1
604 000	8	7 - 8	1



632 443 301 ***

632 443 301 ***	Rozbijač normanálu	Kat.č. 7585
***	(mm)	Balenie (ks)
910	100	1
930	120	1

Pozdĺžne vodoznakové skla ILMADUR ponúkame v dvoch prevedeniach:

- **Sklo reflexné**, ktoré umožňujú jednoduché a bezpečné odčítanie z dostatočnej vzdialenosti
- **Sklo hladké** (transparentné)

V tabuľke sú uvedené základné typy označenia AI až AIX - prierez 30x17 mm a B0 až BXI - prierez 34x17 mm. Dodávame tiež skla typu H - prierez 34x22 mm. Skla typu H sú dodávané vrátane tesnenia. Skla typu A a B sú dodávané bez tesnenia, ktoré je treba objednať zvlášť. Ku každému sklu je treba objednať dve tesnenia - jedno s hrúbkou 1 mm a jedno s hrúbkou 2 mm. Rozmery sú uvedené v tabuľke.

Na požiadanie dodávame sľudové ochranné podložky, ktoré zvyšujú odolnosť skla.

Na požiadanie (za poplatok) Vám môžeme poskytnúť certifikát výrobcu na výrobnú dodávku DIN EN 10 204.

Mechanické vlastnosti

Pevnosť v ohybe:
štandard ≥ 150 N/mm²

Povrchové vytvrdenie
štandard: ≥ 80 N/mm²

Tepelné vytvrdenie zvyšuje existujúcu pevnosť v ohybe minimálne 2x. Tým je garantovaná požiadavka na bezpečnosť sklo podľa DIN 7081.

Teplotné vlastnosti a pracovné podmienky

Maximálna pracovná teplota

Pre trvalé použitie: 280 °C
Pre max. 300 hodín: 300 °C

Pre nasýtenú prehriatu paru
Nechránené sklo do 35 bar: 243 °C
Skla chránené sľudou do 70 bar: 280 °C
Pre média s malým stupňom
zaťaženia do 100 bar: 120 °C

Odolnosť proti teplotnému šoku: ΔT min. 265 °C

634 442 610 ***

Typ B,A reflexné ryhované
pre nižší tlak a teplotu,
lepšia viditeľnosť

***	Typ	Rozmery (mm)
200	B 0	95x34x17
205	B I	115x34x17
210	B II	140x34x17
215	B III	165x34x17
220	B IV	190x34x17
225	B V	220x34x17
230	B VI	250x34x17
235	B VII	280x34x17
240	B VIII	320x34x17
245	B IX	340x34x17
250	B X	370x34x17
255	B XI	400x34x17
605	A I	115x30x17
610	A II	140x30x17
615	A III	165x30x17
620	A IV	190x30x17
625	A V	220x30x17
630	A VI	250x30x17
635	A VII	280x30x17
640	A VIII	320x30x17
645	A IX	340x30x17

634 442 610 ***

Typ B,A hladké - transparentné
pre vyšší tlak a teplotu

***	Typ	Rozmery (mm)
400	B 0	95x34x17
405	B I	115x34x17
410	B II	140x34x17
415	B III	165x34x17
420	B IV	190x34x17
425	B V	220x34x17
430	B VI	250x34x17
435	B VII	280x34x17
440	B VIII	320x34x17
445	B IX	340x34x17
450	B X	370x34x17
455	B XI	400x34x17
805	A I	115x30x17
810	A II	140x30x17
815	A III	165x30x17
820	A IV	190x30x17
825	A V	220x30x17
830	A VI	250x30x17
835	A VII	280x30x17
840	A VIII	320x30x17
845	A IX	340x30x17

624 *** *** *** Tesnenie ku sklám B,A

***	***	***	Typ	Rozmery (mm)
001	610	200	B 0	95x34x75x18x1
002	610	200	B 0	95x34x75x18x2
001	610	205	B I	115x34x95x18x1
002	610	205	B I	115x34x95x18x2
001	610	210	B II	140x34x120x18x1
002	610	210	B II	140x34x120x18x2
001	610	215	B III	165x34x145x18x1
002	610	215	B III	165x34x145x18x2
001	610	220	B IV	190x34x170x18x1
002	610	220	B IV	190x34x170x18x2
001	610	225	B V	220x34x200x18x1
002	610	225	B V	220x34x200x18x2
001	610	230	B VI	250x34x230x18x1
002	610	230	B VI	250x34x230x18x2
001	610	235	B VII	280x34x260x18x1
002	610	235	B VII	280x34x260x18x2
001	610	240	B VIII	320x34x300x18x1
002	610	240	B VIII	320x34x300x18x2
001	610	245	B IX	340x34x320x18x1
002	610	245	B IX	340x34x320x18x2
001	610	250	B X	370x34x350x18x1
002	610	250	B X	370x34x350x18x2
001	610	255	B XI	400x34x380x18x1
002	610	255	B XI	400x34x380x18x2

***	***	***	Typ	Rozmery (mm)
001	610	605	A I	115x30x98x17x1
002	610	605	A I	115x30x98x17x2
001	610	610	A II	140x30x122x17x1
002	610	610	A II	140x30x122x17x2
001	610	615	A III	165x30x147x17x1
002	610	615	A III	165x30x147x17x2
001	610	620	A IV	190x30x172x17x1
002	610	620	A IV	190x30x172x17x2
001	610	625	A V	220x30x200x17x1
002	610	625	A V	220x30x200x17x2
001	610	630	A VI	250x30x230x17x1
002	610	630	A VI	250x30x230x17x2
001	610	635	A VII	280x30x260x17x1
002	610	635	A VII	280x30x260x17x2
001	610	640	A VIII	320x30x300x17x1
002	610	640	A VIII	320x30x300x17x2
001	610	645	A IX	340x30x320x17x1
002	610	645	A IX	340x30x320x17x2

1.1. Laboratórne sklo

634 592 001 *** Typ H - ryhované reflexné		
***	Typ	Rozmery (mm)
261	H I	115x34x22
262	H II	140x34x22
263	H III	165x34x22
264	H IV	190x34x22
265	H V	220x34x22
266	H VI	250x34x22
267	H VII	280x34x22
268	H VIII	320x34x22
269	H IX	340x34x22

Typ H - hladké transparentné		
***	Typ	Rozmery (mm)
272	H II	140x34x22
273	H III	165x34x22
274	H IV	190x34x22
275	H V	220x34x22
276	H VI	250x34x22
277	H VII	280x34x22
278	H VIII	320x34x22
279	H IX	340x34x22

Sklo typu H je dodávané vrátane tesnenia.

Kruhové priezorové sklo ILMADUR podľa DIN 7080

Mechanické vlastnosti

Pevnosť v ohybe
 Štandard: ≥ 160 N/mm²
 Povrchové vytvrdenie
 Štandard: ≥ 100 N/mm²

Teplotné vlastnosti a pracovné podmienky

Maximálna pracovná teplota
 Pre trvalé použitie: 280 °C
 Pre max. 300 hodín,
 alebo pre sklá chránené slúdou: 300 °C

Teplné vytvrdenie zvyšuje existujúcu pevnosť v ohybe minimálne 2,5x. Tým je garantovaná požiadavka na bezpečnosť sklo podľa DIN 7080

Odolnosť proti teplotnému šoku: ΔT min. 265 °C

634 001 *** *** Sklá kruhovú, priezorové ILMADUR podľa DIN 7080					
***	***	Rozmery (mm)	***	***	Rozmery (mm)
310	030	30x10	315	100	100x15
310	040	40x10	320	100	100x20
310	045	45x10	310	120	120x10
310	050	50x10	315	120	120x15
310	055	55x10	320	120	120x20
315	055	55x15	315	125	125x15
320	055	55x20	320	125	125x20
310	060	60x10	325	125	125x25
315	060	60x15	310	130	130x10
310	065	65x10	315	130	130x15
315	065	65x15	320	130	130x20
315	070	70x15	315	140	140x15
320	070	70x20	320	140	140x20
310	080	80x10	315	145	145x15
315	080	80x15	310	150	150x10
320	080	80x20	315	150	150x15
310	090	90x10	320	150	150x20
325	150	150x25	325	150	150x25
315	160	160x15	315	160	160x15
320	160	160x20	320	160	160x20
315	165	165x15	315	165	165x15
315	170	170x15	315	170	170x15
320	170	170x20	320	170	170x20
315	175	175x15	315	175	175x15
320	175	175x20	320	175	175x20
325	175	175x25	325	175	175x25
320	180	180x20	320	180	180x20
315	190	190x15	315	190	190x15
330	195	195x30	330	195	195x30
320	200	200x20	320	200	200x20
330	200	200x30	330	200	200x30
325	250	250x25	325	250	250x25
330	250	250x30	330	250	250x30

639 498 *** *** Sklo dentálne

Kat. č.	Popis	Kat. č.
520 100	Doštička trecia, rozmer 95 x 70 mm	520/1
520 200	Doštička trecia, rozmer 130 x 80 mm	520/2
520 300	Doštička trecia, rozmer 150 x 95 mm	520/3
520 400	Doštička trecia, rozmer 150 x 75 mm	520/4
540 500	Tíčik drsný, priemer 50 mm	540/50
541 350	Palička k tíčiku priemeru 50 mm, menšia	541/35
541 500	Palička k tíčiku priemeru 50 mm, väčšia	541/50
530 000	Mištička číra, guľatá, priemer 30 mm	530/0
530 001	Mištička farebná, guľatá, priemer 30 mm	530/1
531 000	Viečko mištičky číre	531/0
531 001	Viečko mištičky farebné	531/1

632 498 541 ***

634 952 *** *** Sklo hodinové vypuklé s otaveným okrajom Kat.č. 170

***	d (mm)	Hrúbka steny (mm)	Balenie (ks)
430 780	40	1,8	10
430 790	50	1,8	10
430 840	60	1,8	10
430 860	70	1,8	10
430 910	80	1,8	10
430 950	90	1,8	10
430 010	100	1,8	10
430 060	110	1,8	10
430 070	120	1,8	10
430 080	125	1,8	10
430 110	140	1,8	10
430 120	150	1,8	10
420 200	200	1,8	10

634 952 430 ***

634 99* *** **	Sklo - mikrosklo krycie - kruhové SUPERIOR	Kat.č. 3321
****	Priemer (mm)	Balenie (ks)
1 990 499	4	1000
9 049 137	6	1000
0 111 500	10	1000
0 111 520	12	1000
0 111 550	15	1000
0 111 560	16	1000
0 111 580	18	1000
0 111 600	20	1000
0 111 620	22	1000
0 111 640	24	1000

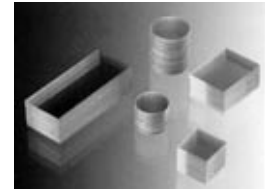

634 99* *** **

634 990 101 ***	Sklo - mikrosklo krycie SUPERIOR, hrúbka č. 1 (0,13-0,17 mm), 1. hydrolytická trieda	Kat.č. 3320
***	Rozmer (mm)	Balenie (ks)
000	12 x 12	1000
010	15 x 15	1000
030	18 x 18	1000
040	20 x 20	1000
050	22 x 22	1000
060	24 x 24	1000
070	18 x 24	1000
120	22 x 40	1000
170	24 x 32	1000
190	24 x 40	1000
220	24 x 50	1000
240	24 x 60	1000

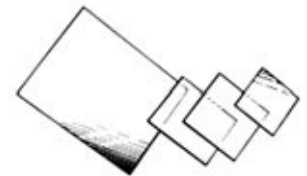

634 990 32* ***

Dodávame aj iné rozmery a hrúbky skiel.

634 *** **	Sklo - mikrosklo krycie k počítačim komôrkam SUPERIOR, hemocytometrické	Kat.č. 3330
*** **	Rozmer (mm)	Balenie (ks)
980 025 035	25 x 35 (Cyrus)	25
990 320 000	20 x 26	100
990 321 000	22 x 22	100
990 322 000	24 x 24	100



634 901 000 ***

634 901 000 ***	Sklo - mikrosklo podložné, SUPERIOR, rezané okraje	Kat.č. 3325
***	Rozmer (mm)	Balenie (ks)
076	76 x 26 x 1	50
078	76 x 26 x 1 obojstranne matovaná plocha	50

634 991 000 ***	Sklo - mikrosklo podložné SUPERIOR brúsené okraje	Kat.č. 3325
***	Rozmer (mm)	Balenie (ks)
412	75 x 25	50
612	76 x 26 obojstranne matovaná plocha	50



634 991 000 412

634 990 *** **	Sklo - mikrosklo podložné s farebnou plochou UniMark	Kat.č. 3325
*** **	Rozmer (mm) Typ okraja Farba plochy	Balenie (ks)
703 110	76x26 Rezaný Žltá	50
704 202	75x25 Brúsený Zelená	50
704 402	75x25 Brúsený Rúžová	50
704 002	75x25 Brúsený Biela	50
704 302	75x25 Brúsený Modrá	50
704 502	75x25 Brúsený oranžová	50



396 996 003 ***

396 996 003 ***	Mikrokrabice na podložné sklá 76 x 26, index na vnútornej strane viečka, plastové rebrovanie	Kat.č. 3326
***	Počet skiel Typ Rozmery (mm)	Balenie (ks)
009	50 Papierová 270 x 100 x 35	1
010	100 Papierová 270 x 190 x 35	1

634 *** **	Sklo - mikrosklo podložné s epoxydovou maskou SUPERIOR brúsené okraje, obojstranná matovaná plocha na popis	Kat.č. 3326
*** **	Rozmer (mm) Farba masky Počet miest	Balenie (ks)
991 216 560	75 x 25 čierna 10 (pr.6 mm)	50

Ponúkame aj ďalšie typy s rôznou farbou masky, počtom a priemerom miest.

1.1. Laboratórne sklo

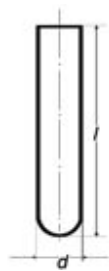

632 423 *** **

632 423 *** ** Skúmavka s guľatým dnom - sodnodraselné sklo Kat.č. 3840/SD rovný okraj

*** **	d (mm)	l (mm)	Síla steny (mm)	Typ	Balenie (ks)
010 087	10	80	1,0	Agglutinačná	760
012 107	12	100	1,0	**	542
014 097	14	90	1,0	Krvná	380
014 107	14	100	1,0	Krvná	380
015 107	15	100	1,0	**	338
015 167	15	160	1,0	Wassermann	325
016 167	16	160	1,0	**	280
016 187	16	180	1,0		315

Rozmery označené v tabuľke ** sú dodávané len pri objednávke nad 20 000 kusov.

Rozmery neuvedené v tabuľke ponúkame na základe požiadavky.

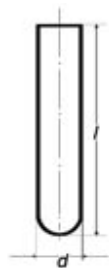

632 422 *** **

632 422 *** ** Skúmavka SIMAX s guľatým dnom, rovný okraj Kat.č. 3840

*** **	d (mm)	l (mm)	Síla steny (mm)	Balenie (ks)
010 107	10	75	1,0	100
010 110	10	100	1,0	100
012 107	12	75	1,0	100
012 110	12	100	1,0	100
014 113	14	130	1,0	100
015 110	15	100	1,2	100
015 116	15	160	1,2	100
015 118	15	180	1,2	100
016 116	16	160	1,2	100
018 118	18	180	1,2	100
020 118	20	180	1,2	100
020 225	20	250	1,2	100
024 120	24	200	1,2	100
030 120	30	200	1,4	100



632 423 *** **

396 137 *** ** Uzáver hliníkový s pružinou na skúmavku s rovným okrajom

*** **	Kat.č	Úprava	d (mm)	Na skúmavku d (mm)	Balenie (ks)
150 044	WK 15004/4	Žltý elox	16	14-15	10
150 034	WK 15003/4	Žltý elox	18	16-17	10

632 423 *** ** Skúmavka s guľatým dnom - sodnodraselné sklo 7830/SD vyhnutý okraj

*** **	d (mm)	l (mm)	Síla steny (mm)	Balenie (ks)
110 087	10	80	1,0	670
115 167	15	160	1,0	290



632 422 1** **

632 422 *** ** Skúmavka s guľatým dnom - SIMAX, vyhnutý okraj Kat.č. 7830

*** **	d (mm)	l (mm)	Síla steny (mm)	Balenie (ks)
110 107	10	75	1,0	100
110 110	10	100	1,0	100
112 107	12	75	1,0	100
112 110	12	100	1,0	100
114 113	14	130	1,0	100
116 115	16	150	1,2	100
118 118	18	180	1,2	100
120 115	20	150	1,2	100
120 118	20	180	1,2	100
124 115	24	150	1,2	100
124 120	24	200	1,2	100
130 120	30	200	1,4	100

632 422 *** ** Skúmavka s guľatým dnom - SIMAX s kovovým uzáverom Kat.č. 7834

*** **	d (mm)	l (mm)	Síla steny (mm)	Balenie (ks)
821 711	17	120	1,2	1
821 712	17	160	1,2	1

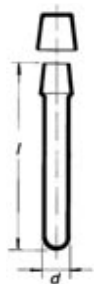

632 422 821 ***

632 422 *** ** Skúmavka s rovným dnom, rovný okraj - SIMAX Kat.č. 2422

*** **	d (mm)	l (mm)	Síla steny (mm)	Balenie (ks)
219 416	19	160	1,2	10

632 422 *** ** Skúmavka so špicatým dnom - SIMAX				Kat.č. 3820
s rovným okrajom, kónicka				
*** **	d (mm)	l (mm)	Sila steny (mm)	Balenie (ks)
409 210	9	100	1,5	50
414 208	14	80	1,5	50
416 212	16	120	1,8	50

632 422 *** ** Skúmavka so špicatým dnom - SIMAX				Kat.č. 3821
s vyhnutým okrajom, kónicka				
*** **	d (mm)	l (mm)	Sila steny (mm)	Balenie (ks)
514 210	14	100	1,5	50
514 212	14	120	1,5	50
515 108	15	80	1,2	50
515 110	15	100	1,2	50
516 210	16	100	1,8	50
516 212	16	120	1,8	50
517 112	17	120	1,2	50

632 422 *** ** Skúmavka so špicatým dnom - SIMAX				Kat.č. 2801
s rovným okrajom, centrifugačná				
*** **	d (mm)	l (mm)	Sila steny (mm)	Balenie (ks)
417 290	17	98	1,8	50
424 290	24	98	1,8	50
436 290	36	98	2,0	50
440 211	40	115	2,3	50

632 422 *** ** Skúmavka s guľatým dnom - SIMAX					Kat.č. 3830
s GL uzáverom					
*** **	d (mm)	l (mm)	Sila steny (mm)	GL	Balenie (ks)
631 610	16	100	1,8	18	50
631 612	16	120	1,8	18	50
631 616	16	160	1,8	18	50

632 437 *** ** Skúmavka centrifugačná - SIMAX				Kat.č. 3822
s delenou stupnicou				
*** **	Objem (ml)	d (mm)	l (mm)	Balenie (ks)
210 819	10	17	120	1
210 821	15	18	140	1
210 823	25	24	150	1

632 437 *** ** Skúmavka kalibrovaná - SIMAX				Kat.č. 7841
s NZ 14/15 a skl. zátkou				
*** **	Objem (ml)	NZ (mm)	h (mm)	Balenie (ks)
860 297	25	14 / 15	190	1

632 437 *** ** Skúmavka reagenčná s vyhnutým okrajom - SIMAX						Kat.č. 7832
s delenou stupnicou						
*** **	Objem (ml)	Del.(mm)	d (mm)	l (mm)	Balenie (ks)	
010 719	10	0,1	13	150	1	
010 721	15	0,1	15	160	1	
010 822	20	0,2	17	160	1	
010 823	25	0,2	17	190	1	
010 925	50	0,5	22	250	1	

632 441 746 *** Spoj skrutkový GL					Kat.č. 746
***	d (mm)	h (mm)	GL (mm)	Balenie (ks)	
200	12	120	14	1	
400	16	120	18	1	
600	22	150	25	1	
800	30	150	32	1	



632 422 409 210



632 422 514 210



632 422 417 290

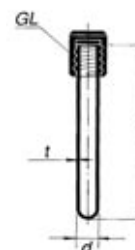

632 422 631 610



632 437 210 819



632 437 860 297



632 437 010 719

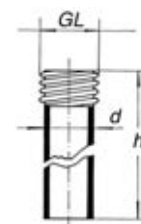

632 441 746 ***

1.1. Laboratórne sklo

Trubice a tyče Simax

Trubice a tyče sú spracované v nasledujúcich tabuľkách. Všetky priemery sa vyrábajú v štandardných dĺžkach 1500 mm s rôznou silou steny. Dodávame ich len po baleniach. Okrem uvedeného sortimentu dodávame aj ostatné výrobky Sklární Kavalier Sázava, podmienkou je rovnako odber na balenie. Ide o sklenené kapiláry, ploché kapiláry, tvarované trubice (rýhované, trojlistok, šesťlistok) a ploché tyče.

Trubice	Dĺžka / úprava koncov
4-7 mm	1500±20 mm / rezané
7-10 mm	1500±10 mm / rezané
10-48 mm	1500±10 mm / rezané a zapalované
48-150 mm	1500± 5 mm / rezané a zapalované



Kapiláry a tyče	Dĺžka / úprava koncov
3-7 mm	1500±20 mm / rezané
7-17 mm	1500±10 mm / rezané
17-30 mm	1500±30 mm / rezané



Vysvetlivky: priemerom sa rozumie vonkajší priemer trubice s povolenou odchylkou
 ss = sila steny v mm
 xxx = dopĺňujúce trojčíslicie určujúce ss.

632 *** ** xxx	Trubice	Priemer (mm)	ss tenká xxx	ss stredná xxx	ss tlstá xxx	ks/kartón	kg/karton	
246 040 xxx	4,0+/-0,2	0,8	080	-	-	400	10,8	
246 050 xxx	5,0+/-0,2	0,8	080	-	-	256	9	
246 060 xxx	6,0+/-0,2	1,0	100	1,5	150	170	9,0 / 12,1	
246 070 xxx	7,0+/-0,2	1,0	100	1,5	150	121	7,6 / 10,5	
246 080 xxx	8,0+/-0,2	1,0	100	1,5	150	100	7,4 / 10,2	
246 090 xxx	9,0+/-0,2	1,0	100	1,5	150	81	6,8 / 9,6	
246 100 xxx	10,0+/-0,25	1,0	100	1,5	150	2,2 220	64	6,1/8,6/11,5
246 110 xxx	11,0+/-0,25	1,0	100	1,5	150	2,2 220	121/121/50	12,7/18,2/10,2
246 120 xxx	12,0+/-0,25	1,0	100	1,5	150	2,2 220	100/100/49	11,6/16,6/11,1
246 130 xxx	13,0+/-0,25	1,0	100	1,5	150	2,2 220	81	10,2/14,7/20,3
246 140 xxx	14,0+/-0,25	1,0	100	1,5	150	2,2 220	64	8,8/12,6/17,5
246 150 xxx	15,0+/-0,25	1,2	120	1,8	180	2,5 250	49	8,5/12,3/16,1
246 160 xxx	16,0+/-0,25	1,2	120	1,8	180	2,5 250	49	9,2/13,2/17,4
246 170 xxx	17,0+/-0,25	1,2	120	1,8	180	2,5 250	36	7,2/10,4/13,7
246 180 xxx	18,0+/-0,25	1,2	120	1,8	180	2,5 250	36	7,6/11,0/14,7
246 190 xxx	19,0+/-0,25	1,2	120	1,8	180	2,5 250	64/64/36	14,3/20,8/15,6
246 200 xxx	20,0+/-0,25	1,2	120	1,8	180	2,5 250	49	11,6/16,9/22,5
246 220 xxx	22,0+/-0,3	1,2	120	1,8	180	2,5 250	36	9,4/13,8/18,4
246 240 xxx	24,0+/-0,3	1,2	120	1,8	180	2,5 250	36	10,4/15,1/20,3
246 260 xxx	26,0+/-0,3	1,4	140	2,0	200	2,8 280	36	13,0/18,1/24,6
246 280 xxx	28,0+/-0,3	1,4	140	2,0	200	2,8 280	25	9,8/13,7/18,5
246 300 xxx	30,0+/-0,6	1,4	140	2,0	200	2,8 280	36/36/25	15,2/21,2/20,0
246 320 xxx	32,0+/-0,6	1,4	140	2,0	200	2,8 280	25	11,3/15,8/21,5
246 340 xxx	34,0+/-0,6	1,4	140	2,0	200	2,8 280	16	7,7/10,8/14,7
246 360 xxx	36,0+/-0,6	1,4	140	2,0	200	2,8 280	16	8,1/11,4/15,6
246 380 xxx	38,0+/-0,6	1,4	140	2,0	200	2,8 280	16	8,6/12,1/16,6
246 400 xxx	40,0+/-0,8	1,6	160	2,3	230	3,2 320	16	10,3/14,6/19,8
246 420 xxx	42,0+/-0,8	1,6	160	2,3	230	3,2 320	16	10,9/15,4/20,9
246 440 xxx	44,0+/-0,8	1,6	160	2,3	230	3,2 320	16	11,4/16,1/22,0
246 460 xxx	46,0+/-0,8	1,6	160	2,3	230	3,2 320	16	12,0/16,9/23,0
246 480 xxx	48,0+/-0,8	1,6	160	2,3	230	3,2 320	9	7,0/9,9/13,6
246 500 xxx	50,0+/-1,0	1,8	180	2,5	250	3,5 350	12/12/9	10,9/15,0/15,4
246 520 xxx	52,0+/-1,0	1,8	180	2,5	250	3,5 350	12/12/9	11,4/15,6/16,1
246 540 xxx	54,0+/-1,0	1,8	180	2,5	250	3,5 350	9	8,9/12,2/16,7
246 560 xxx	56,0+/-1,0	1,8	180	2,5	250	3,5 350	12/12/9	12,3/16,9/17,4
246 580 xxx	58,0+/-1,0	1,8	180	2,5	250	3,5 350	12/12/4	12,8/17,5/8,0

632 *** ** xxx	Trubice	Priemer (mm)	ss tenká xxx	ss stredná xxx	ss tlstá xxx	ss tlstá xxx	ks/kartón	kg/karton	
246 600 xxx	60,0+/-1,2	2,2	220	3,2	320	4,2 420	5,0 500	12/12/4/4	16/22,9/9,9/11,6
246 650 xxx	65,0+/-1,2	2,2	220	3,2	320	4,2 420	5,0 500	8/8/8/4	11,6/16,6/21,5/12,6
246 700 xxx	70,0+/-1,2	2,2	220	3,2	320	4,2 420	5,0 500	8/8/8/4	12,5/18,0/23,2/13,7
246 750 xxx	75,0+/-1,2	2,2	220	3,2	320	4,2 420	5,0 500	4	6,7/9,7/12,5/14,7
246 800 xxx	80,0+/-1,5	2,5	250	3,5	350	5,0 500	-	4	8,1/11,3/15,8
246 850 xxx	85,0+/-1,5	2,5	250	3,5	350	5,0 500	-	4	8,7/12,0/16,8
246 900 xxx	90,0+/-1,5	2,5	250	3,5	350	5,0 500	-	4	9,2/12,7/17,9
246 950 xxx	95,0+/-1,5	2,5	250	3,5	350	5,0 500	-	4	9,7/13,5/18,9
248 000 xxx	100,0+/-1,5	2,5	250	3,5	350	5,0 500	-	3	7,7/10,6/15,0
248 050 xxx	105,0+/-1,8	-	-	3,0	300	5,0 500	-	3	9,6/15,8
248 100 xxx	110,0+/-1,8	-	-	3,0	300	5,0 500	-	3	10,1/16,6
248 150 xxx	115,0+/-1,8	-	-	3,0	300	5,0 500	-	3	10,6/17,3
248 200 xxx	120,0+/-1,8	-	-	3,0	300	5,0 500	-	3	11,1/18,1
248 250 xxx	125,0+/-1,8	-	-	3,0	300	5,0 500	-	3	11,5/18,9
248 300 xxx	130,0+/-1,8	-	-	3,0	300	5,0 500	-	2	8,0/13,1
248 350 xxx	135,0+/-1,8	-	-	3,0	300	5,0 500	-	2	8,3/13,7
248 400 xxx	140,0+/-2,0	-	-	3,0	300	5,0 500	-	2	8,6/14,2
248 450 xxx	145,0+/-2,0	-	-	3,0	300	5,0 500	-	2	9,0/14,7
248 500 xxx	150,0+/-2,0	-	-	3,0	300	5,0 500	-	1	4,6/7,6

632 271 *** *** Tyče SIMAX				
*** **	Priemer (mm)	ks/kartón	kg/kartón	kg/paleta
030 000	3,0±0,2	700	16,8	470,4
040 000	4,0±0,2	400	16,8	470,4
050 000	5,0±0,2	256	16,9	473,2
060 000	6,0±0,2	170	16,2	453,6
070 000	7,0±0,2	121	15,6	436,8
080 000	8,0±0,25	100	16,8	470,4
090 000	9,0±0,25	81	17,3	484,4
100 000	10,0±0,25	64	16,8	470,4
110 000	11,0±0,25	50	15,9	445,2
120 000	12,0±0,25	49	18,5	388,5
130 000	13,0±0,35	36	16,0	448,0
140 000	14,0±0,35	25	12,9	451,5
150 000	15,0±0,35	25	14,8	414,4
160 000	16,0±0,35	16	10,8	378,0
180 000	18,0±0,45	16	13,6	380,8
200 000	20,0±0,45	16	16,8	470,4
220 000	22,0±0,5	9	11,4	399,0
240 000	24,0±0,5	9	13,6	380,8
260 000	26,0±0,6	9	16,0	448,0
280 000	28,0±0,9	4	8,2	287,0
300 000	30,0±0,9	4	9,5	332,5



632 271 *** ***

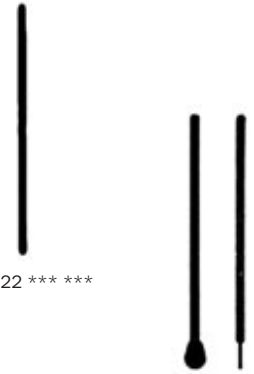

632 522 *** ***

632 522 *** *** Tyčinka miešacia otavená			Kat. č. 7765
*** **	Priemer x dĺžka (mm)		Balenie (ks)
203 506	4 x 200		10
204 502	5 x 200		10
201 500	5 x 250		10
204 503	5 x 300		10
205 502	6 x 200		10
205 503	6 x 300		10
206 502	7 x 200		10
206 503	7 x 300		10
207 503	8 x 300		10
207 504	8 x 400		10
209 003	9 x 300		10
209 004	9 x 400		10

632 522 213 ***

632 522 *** *** Tyčinka s lopatkou			Kat. č. 3150
*** **	Priemer x dĺžka (mm)	Sklovina	Balenie (ks)
213 501	4 x 100	Simax	1
213 562	5 x 60-65	Simax	1
213 565	4 x 65	Simax	1



632 432 110 ***

632 432 111 ***

632 432 *** *** Valec odmerný vysoký, trieda presnosti A					Kat.č. 1634/AM	
modrá graduácia,						
*** **	Objem(ml)	Presnosť(±ml)	Del.(mm)	d (mm)	h (mm)	Balenie (ks)
110 718	5	0,05	0,1	12,9	115	1
110 819	10	0,10	0,2	15,9	135	1
110 923	25	0,20	0,5	21,3	160	1
111 125	50	0,50	1,0	26,0	195	1
111 130	100	0,50	1,0	31,3	240	1
111 238	250	1,00	2,0	41,0	320	1
111 343	500	2,50	5,0	53,2	380	1
111 444	1000	5,00	10,0	67,0	465	1
111 546	2000	10,00	20,0	83,5	565	1

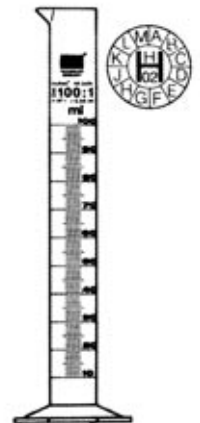

634 702 *** ***

634 702 *** *** Valec odmerný vysoký, triedad presnosti A,					Kat.č. 1634/AHH
HIRSCHMANN hnedá graduácia					
*** **	Objem(ml)	Presnosť(±ml)	Del.(mm)	h (mm)	Balenie (ks)
210 154	5	0,05	0,1	115	2
210 160	10	0,10	0,2	140	2
210 170	25	0,25	0,5	170	2
210 175	50	0,50	1,0	200	2
210 180	100	0,50	1,0	260	2
210 186	250	1,00	2,0	355	2
210 190	500	2,50	5,0	390	2
210 193	1000	5,00	10,0	470	2
210 194	2000	10,00	20,0	570	1

1.1. Laboratórne sklo



632 432 140 ***
632 432 141 ***



632 432 150 ***
632 432 151 ***

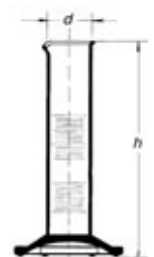

632 432 340 ***
632 432 341 ***

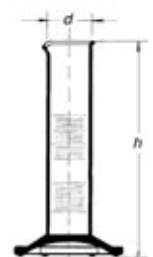

632 432 350 ***
632 432 351 ***

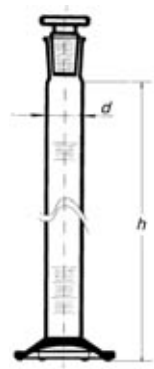

632 432 240 ***
632 432 241 ***



632 432 250 ***
632 432 251 ***

632 432 *** *** Valec odmerný vysoký, trieda presnosti B Kat.č. 1634/BB

		biela graduácia,					
*** ***	Objem(ml)	Presnosť(±ml)	Del.(mm)	d (mm)	h (mm)	Balenie (ks)	
140 718	5	0,1	0,1	12,9	115	1	
140 819	10	0,2	0,2	15,9	135	1	
140 923	25	0,5	0,5	21,3	160	1	
141 125	50	1,0	1,0	26,0	195	1	
141 130	100	1,0	1,0	31,3	240	1	
141 238	250	2,0	2,0	41,0	320	1	
141 343	500	5,0	5,0	53,2	380	1	
141 444	1000	10,0	10,0	67,0	465	1	
141 546	2000	20,0	20,0	83,5	565	1	

632 432 *** *** Valec odmerný vysoký, trieda presnosti B Kat.č. 1634/BH

		hnedá graduácia,					
*** ***	Objem(ml)	Presnosť(±ml)	Del.(mm)	d (mm)	h (mm)	Balenie (ks)	
150 718	5	0,1	0,1	12,9	115	1	
150 819	10	0,2	0,2	15,9	135	1	
150 923	25	0,5	0,5	21,3	160	1	
151 125	50	1,0	1,0	26,0	195	1	
151 130	100	1,0	1,0	31,3	240	1	
151 238	250	2,0	2,0	41,0	320	1	
151 343	500	5,0	5,0	53,2	380	1	
151 444	1000	10,0	10,0	67,0	465	1	
151 546	2000	20,0	20,0	83,5	565	1	

632 432 *** *** Valec odmerný nízky, trieda presnosti B Kat.č. 1645/BB

		biela graduácia,					
*** ***	Objem(ml)	Presnosť(±ml)	Del.(mm)	d (mm)	h (mm)	Balenie (ks)	
340 818	5	0,2	0,2	15,5	90	10	
340 919	10	0,5	0,5	21,3	100	10	
341 123	25	1,0	1,0	26,0	125	10	
341 125	50	1,0	1,0	31,3	150	10	
341 230	100	2,0	2,0	41,0	170	10	
341 338	250	5,0	5,0	53,2	235	10	
341 443	500	10,0	10,0	67,0	280	8	
341 544	1000	20,0	20,0	83,5	340	5	
711 746	2000	50,0	50,0	95,0	420	6	

632 432 *** *** Valec odmerný nízky, trieda presnosti B Kat.č. 1645/BH

		hnedá graduácia,					
*** ***	Objem(ml)	Presnosť(±ml)	Del.(mm)	d (mm)	h (mm)	Balenie (ks)	
350 818	5	0,2	0,2	15,5	90	10	
350 919	10	0,5	0,5	21,3	100	10	
351 123	25	1,0	1,0	26,0	125	10	
351 125	50	1,0	1,0	31,3	150	10	
351 230	100	2,0	2,0	41,0	170	10	
351 338	250	5,0	5,0	53,2	235	10	
351 443	500	10,0	10,0	67,0	280	8	
351 544	1000	20,0	20,0	83,5	340	5	
721 746	2000	50,0	50,0	95,0	420	6	

632 432 *** *** Valec odmerný s NZ, trieda presnosti B Kat.č. 1652/BBS

		so sklenenou zátkou, biela graduácia,					
*** ***	Objem(ml)	Presnosť(±ml)	Del.(mm)	d (mm)	h (mm)	NZ	Balenie (ks)
240 718	5	0,1	0,1	12,9	115	10/19	10
240 819	10	0,2	0,2	15,5	135	10/19	10
240 923	25	0,5	0,5	21,3	160	14/23	10
241 125	50	1,0	1,0	26,0	195	19/26	10
241 130	100	1,0	1,0	31,3	240	24/29	10
241 238	250	2,0	2,0	41,0	320	29/32	10
241 343	500	5,0	5,0	53,2	380	34/35	10
241 444	1000	10,0	10,0	67,0	465	45/40	4
241 546	2000	20,0	20,0	83,5	565	45/40	3

632 432 *** *** Valec odmerný s NZ, trieda presnosti B Kat.č. 1652/BHS

		so sklenenou zátkou, hnedá graduácia,					
*** ***	Objem(ml)	Presnosť(±ml)	Del.(mm)	d (mm)	h (mm)	NZ	Balenie (ks)
250 718	5	0,1	0,1	12,9	115	10/19	10
250 819	10	0,2	0,2	15,5	135	10/19	10
250 923	25	0,5	0,5	21,3	160	14/23	10
251 125	50	1,0	1,0	26,0	195	19/26	10
251 130	100	1,0	1,0	31,3	240	24/29	10
251 238	250	2,0	2,0	41,0	320	29/32	10
251 343	500	5,0	5,0	53,2	380	34/35	10
251 444	1000	10,0	10,0	67,0	465	45/40	4
251 546	2000	20,0	20,0	83,5	565	45/40	3

632 432 *** ***		Valec odmerný s NZ, trieda presnosti A so sklenenou zátkou, modrá graduácia,				Kat.č. 1652/AMS	
*** ***	Objem(ml)	Presnosť(±ml)	Delenie(mm)	d (mm)	h (mm)	NZ	Balenie (ks)
210 718	5	0,1	0,1	12,9	115	10/19	10
210 819	10	0,2	0,2	15,5	135	10/19	10
210 923	25	0,5	0,5	21,3	160	14/23	10
211 125	50	1,0	1,0	26,0	195	19/26	10
211 130	100	1,0	1,0	31,3	240	24/29	10
211 238	250	2,0	2,0	41,0	320	29/32	10
211 343	500	5,0	5,0	53,2	380	34/35	10
211 444	1000	10,0	10,0	67,0	465	45/40	4
211 546	2000	20,0	20,0	83,5	565	45/40	3



632 432 210 ***

632 432 *** ***		Valec odmerný s NZ, trieda presnosti B s plastovou zátkou, hnedá graduácia,				Kat.č. 1652/BHPN	
*** ***	Objem(ml)	Presnosť(±ml)	Del. (mm)	d (mm)	h (mm)	NZ	Balenie (ks)
626 018	5	0,1	0,1	12,9	115	10/19	10
626 019	10	0,2	0,2	15,5	135	10/19	10
626 023	25	0,5	0,5	21,3	160	14/23	10
626 025	50	1,0	1,0	26,0	195	19/26	10
626 030	100	1,0	1,0	31,3	240	24/29	10
626 038	250	2,0	2,0	41,0	320	29/32	10
626 043	500	5,0	5,0	53,2	380	34/35	10
626 044	1000	10,0	10,0	67,0	465	45/40	4
626 046	2000	20,0	20,0	83,5	565	45/40	3

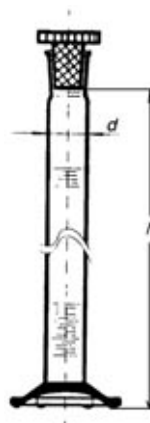
632 432 626 ***
632 432 627 ***
632 432 630 ***

632 432 *** ***		Valec odmerný s NZ, trieda presnosti B a plastovou zátkou, biela graduácia,				Kat.č. 1652/BBPN	
*** ***	Objem(ml)	Presnosť(±ml)	Del. (mm)	d (mm)	h (mm)	NZ	Balenie (ks)
627 018	5	0,1	0,1	12,9	115	10/19	10
627 019	10	0,2	0,2	15,5	135	10/19	10
627 023	25	0,5	0,5	21,3	160	14/23	10
627 025	50	1,0	1,0	26,0	195	19/26	10
627 030	100	1,0	1,0	31,3	240	24/29	10
627 038	250	2,0	2,0	41,0	320	29/32	10
627 043	500	5,0	5,0	53,2	380	34/35	10
627 044	1000	10,0	10,0	67,0	465	45/40	4
627 046	2000	20,0	20,0	83,5	565	45/40	3

632 432 *** ***		Valec odmerný s NZ, trieda presnosti A s plastovou zátkou, modrá graduácia				Kat.č. 1652/AMPN	
*** ***	Objem(ml)	Presnosť(±ml)	Del. (mm)	d (mm)	h (mm)	NZ	Balenie (ks)
630 018	5	0,1	0,1	12,9	115	10/19	10
630 019	10	0,2	0,2	15,5	135	10/19	10
630 023	25	0,5	0,5	21,3	160	14/23	10
630 025	50	1,0	1,0	26,0	195	19/26	10
630 030	100	1,0	1,0	31,3	240	24/29	10
630 038	250	2,0	2,0	41,0	320	29/32	10
630 043	500	5,0	5,0	53,2	380	34/35	10
630 044	1000	10,0	10,0	67,0	465	45/40	4
630 046	2000	20,0	20,0	83,5	565	45/40	3

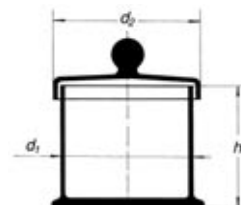

633 416 *** ***		Valec preparátny s voľným previslým viečkom a guľičkovým hmatníkom		Kat.č. 2708/SD	
*** ***	d (mm)	h (mm)	Balenie (ks)		
130 858	80	80	1		
131 010	100	100	1		
131 212	120	120	1		
131 515	150	150	1		

632 416 130 ***
632 416 131 ***

632 432 *** ***		Valec pre zrážkomery – dažďomer s guľatou patkou				Kat.č. 1660	
*** ***	Objem (ml)	d (mm)	h (mm)	Del.	Balenie (ks)		
402 843	520	56	315	0 - 10	1		
402 944	600	56	370	0 - 12	1		

632 432 *** ***		Valec pre zrážkomery – dažďomer s šesťhrannou patkou			Kat.č. 1661	
*** ***	Objem (ml)	Delenie		Balenie (ks)		
416 543	500	5 : 1		1		

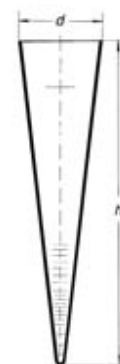

632 432 430 ***

632 432 430 ***		Valec sedimentačný podľa Imhoffa s uzavretou špičkou				Kat.č. 2745	
***	Objem (ml)	d (mm)	h (mm)	Delenie	Balenie (ks)		
044	1000	118	470	české	10		
144	1000	118	470	nemecké	10		
244	1000	118	470	švajčiarské	10		

1.1. Laboratórne sklo

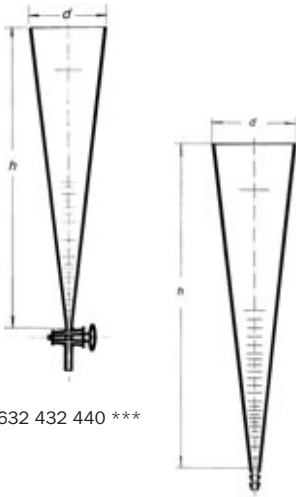

632 432 440 ***

632 432 450 044

632 432 440 *** Valec sedimentačný podľa Imhoffa s kohútom Kat.č. 2746

***	Objem (ml)	d (mm)	h (mm)	Delenie	Balenie (ks)
044	1000	118	470	české	1
144	1000	118	470	nemecké	10
244	1000	118	470	švajčiarské	10

632 432 450 *** Valec sedimentačný podľa Imhoffa špička zakončená olivkou Kat.č. 2747

***	Objem (ml)	d (mm)	h (mm)	Delenie	Balenie (ks)
044	1000	118	470	České	10

Delenie sedimentačných valcov Imhoffa:

	0-5 ml	5-10 ml	10-50 ml	50-100 ml	100-1000 ml	1000 ml
České	0-5 ml	5-10 ml	10-50 ml	50-100 ml	100-1000 ml	1000 ml
delenie po:	0,1 ml	0,5 ml	1 ml	2 ml	bez delenia	ryska
Nemecké	0-2 ml	2-10 ml	10-40 ml	40-100 ml	100-1000 ml	1000 ml
delenie po:	0,1 ml	0,5 ml	1 ml	2 ml	bez delenia	ryska
Švajčiarské	0-5 ml	5-20 ml		20-100 ml	100-1000 ml	1000 ml
delenie po:	0,5 ml	1 ml		5 ml	50 ml	ryska

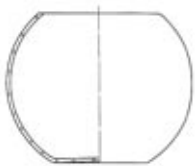

632 *** *** ***

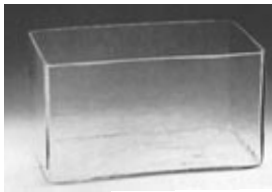

631 *** *** ***

631 912 129 *** Vaňa sklenená guľatá sodnodraselné sklo

***	Objem (l)	Priemer (mm)	Balenie (ks)
324	2	165	10
356	3,5	200	4
357	10	280	1
360	12	300	1

631 *** *** *** Vaňa sklenená sklenená hranatá sodnodraselné sklo

*** *** ***	Výška (mm)	Sírka (mm)	Dĺžka (mm)	Balenie (ks)
100 100 100	100	100	100	1
100 100 200	100	100	200	1
150 100 150	150	100	150	1
150 150 250	150	150	250	1
220 180 250	220	180	250	1
240 220 300	240	220	300	1

632 442 *** *** Ventil teflónový Kat.č. 4426

*** ***	Typ	Priemer (mm)	Typ	Balenie (ks)
636 020	Jednocestný priamy A	2	VT 0-2	1
637 020	Jednocestný priamy B	2	VT 0-2	1



632 442 366 020

632 733 111 *** Viskozimeter U pre nepriehľadné kvapaliny

***	Priemer kapiláry (mm)	Typ	Rozsah merania (mm ² .s ⁻¹)	Balenie (ks)
010	0,51±0,02	1	0,6-3	1
020	0,71±0,02	2	2-10	1
030	0,93±0,03	3	6-30	1
040	1,26±0,04	4	20-100	1
050	1,64±0,05	5	60-300	1
060	2,24±0,07	6	200-1000	1
070	2,93±0,1	7	600-3000	1
080	4,0±0,1	8	2000-10000	1

632 733 006 *** Viskozimeter podľa Ostvalda Kat.č. 7781

***	Priemer kapiláry (mm)	Typ	Rozsah merania (mm ² .s ⁻¹)	Balenie (ks)
010	1,15±0,05	O I	5-40	1
020	2,23±0,05	O II	30-50	1
030	3,80±0,05	O III	200-1500	1

632 733 100 *** Viskozimeter podľa Ubbelohdeho Kat.č. 7784

***	Priemer kapiláry (mm)	Typ	Konštanta	Rozsah mer. (mm ² .s ⁻¹)	Balenie (ks)
020	0,46±0,02	Oa	0,003	0,5-3	1
030	0,64±0,02	I	0,01	2-10	1
040	0,84±0,02	Ia	0,03	6-30	1
050	1,13±0,03	II	0,1	20-100	1
060	1,48±0,03	Ila	0,3	60-300	1
070	2,01±0,05	III	1,0	200-1000	1
080	2,64±0,07	IIIa	3,0	600-3000	1
090	3,57±0,1	IV	10,0	2000-10000	1

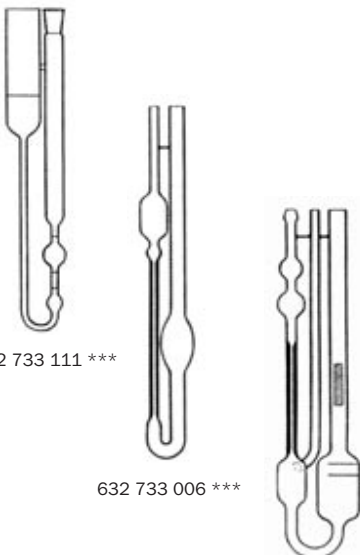

632 733 111 ***

632 733 006 ***

632 733 100 ***

632 441 509 *** Vložka prechodová - redukcia					Kat.č. 8127
***	d (mm)	l (mm)	NZ ₁	NZ ₂	Balenie (ks)
055	26	38	14/23	29/32	1
088	40	57	29/32	45/40	1
080	53	62	29/32	60/46	1
091	62	79	45/40	71/51	1

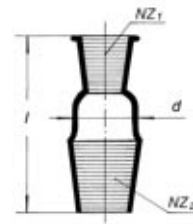

632 441 509 ***

632 441 510 *** Vložka prechodová - redukcia obrátená					Kat.č. 8128
***	l (mm)	NZ ₁	NZ ₂	Balenie (ks)	
051	20	14/23	12/21	1	
062	20	19/26	14/23	1	
073	25	24/29	19/26	1	
082	35	29/32	14/23	1	
083	35	29/32	19/26	1	
084	35	29/32	24/29	1	
114	45	45/40	24/29	1	
115	45	45/40	29/32	1	

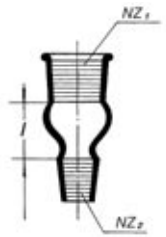

632 441 510 ***

632 522 273 *** Vtieratko očné - lyžička očná		Kat. č. 3582
***	Priemer x dĺžka (mm)	
501	4 x 100	

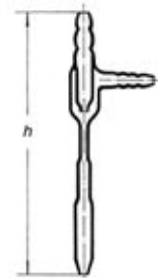

632 444 001 *** Výveva vodná		Kat.č. 7790
***	h (mm)	Balenie (ks)
000	220	1

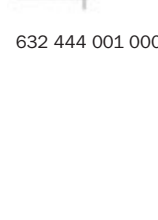

632 444 001 000

632 443 611 *** Vzorkovnica na plyny s dvoma olivkami (na gúmy a tlačky)				Kat.č. 7500/GT
***	Objem (ml)	d (mm)	l (mm)	Balenie (ks)
100	100	38	200	1
150	150	43	210	1
250	250	52	230	1
500	500	68	260	1
940	1000	86	320	1
950	2000	110	390	1

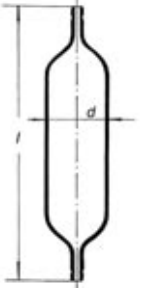

632 443 611 ***

632 443 606 *** Vzorkovnica na plyny s jednocestným a jedným trojcestným kohútom				Kat.č. 7500
***	Objem (ml)	d (mm)	l (mm)	Balenie (ks)
100	100	38	235	1
150	150	43	245	1
250	250	52	280	1
500	500	68	310	1
940	1000	86	390	1
950	2000	110	460	1

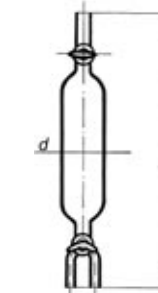

632 443 606 ***

632 441 503 *** Zábrus normalizovaný (NZ) - jadro				Kat.č. 8120
***	NZ	d (mm)	l (mm)	Balenie (ks)
010	5 / 13	5	120	1
020	7 / 16	7	120	1
030	10 / 19	8	120	1
040	12 / 21	11	120	1
050	14 / 23	13	120	1
060	19 / 26	17	150	1
070	24 / 29	22	150	1
080	29 / 32	26	150	1
100	40 / 38	36	150	1
110	45 / 40	40	150	1
130	60 / 46	56	200	1
140	71 / 51	65	200	1
150	85 / 55	80	200	1
160	100 / 60	95	200	1

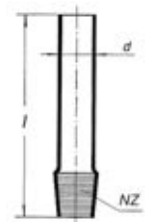

632 441 503 ***

632 441 512 *** Zábrus normalizovaný (NZ) - plášť				Kat.č. 8124
***	NZ	d (mm)	l (mm)	Balenie (ks)
040	12 / 21	16	120	1
050	14 / 23	18	120	1
060	19 / 26	22	150	1
070	24 / 29	28	150	1
080	29 / 32	34	150	1
110	45 / 40	50	150	1

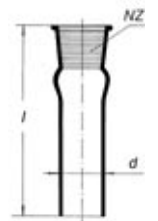

632 441 504 ***

1.1. Laboratórne sklo



632 442 206 ***

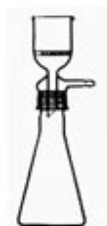

632 442 207 ***

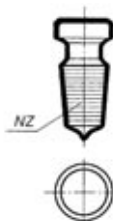

632 493 505 ***

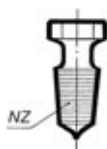

632 493 503 ***

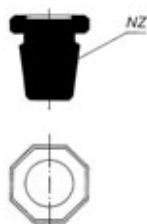

632 493 501 ***

632 442 206 *** Zariadenie filtračné podľa Witta			Kat.č. 2408
***	d (mm)	h (mm)	Balenie (ks)
070	70	110	1
090	90	140	1
091	110	160	1

632 442 207 *** Zariadenie filtračné podľa Mortona			Kat.č. 2409
***	Objem (ml)	Pórovitosť (µm)	Balenie (ks)
001	250	S 1	1
002	250	S 2	1
003	250	S 3	1
004	250	S 4	1

632 493 505 *** Zátka dutá - hribkovitá s NZ			Kat.č. 7171
***	NZ		Balenie (ks)
040	12/21		1
050	14/23		1
060	19/26		1
070	24/29		1
080	29/32		1

632 493 503 *** Zátka dutá - šesťhranná s NZ			Kat.č. 8131
***	NZ		Balenie (ks)
040	12/21		1
050	14/23		1
060	19/26		1
070	24/29		1
080	29/32		1

632 493 *** *** Zátka plná - osemhranná s NZ			Kat.č. 8130	
***	***	Typ	NZ	Balenie (ks)
501	020	plná	7/16	1
501	030	plná	10/19	1
501	040	plná	12/21	1
501	050	plná	14/23	1
501	060	plná	19/26	1
501	070	plná	24/29	1
501	080	plná	29/32	1
502	080	odľahčená	29/32	1
502	090	odľahčená	34/35	1
508	110	odľahčená	45/40	1